



LEON COUNTY AUDITOR'S OFFICE

Melissa B. Abney, County Auditor

P.O. Box 898, 113 West Main Street, Centerville, Texas 75833 (903)536-2709 (903)536-5801 Fax

April 19, 2023

Invitation for Bid

Dear Bidders:

You are invited to submit bids in accordance with the attached specification packet, Invitation for Bid #2023-272B Fencing Construction and Installation. All bids must be submitted with an original and one (1) copy to the Leon County Auditor's Office, 113 West Main Street, 2nd Floor, Centerville, Texas 75833, no later than 3:00 PM, Thursday, May 4, 2023. Bids will be opened at 3:05 PM, May 4, 2023, in the Auditor's Conference Room located in the Auditor's Office on the second floor of Annex I.

All questions regarding this bid solicitation must be in writing and may be sent by email to debbie.reeder@co.leon.tx.us or faxed to 903-536-5801 to the attention of Debbie Reeder no later than four business days prior to the due date. It is the responsibility of each vendor to examine the entire bid package, seek clarification in writing and review their bid for accuracy before submitting. The County will not be bound by any information conveyed verbally.

All Bids shall be submitted to the Leon County Auditor's Office in a sealed envelope marked:

BID NO. 2023-272B

Fencing Construction and Installation

Your consideration of this bid request is appreciated.

Sincerely,

Debbie Reeder
Assistant Auditor

Attachments

TABLE OF CONTENTS

	Page
Bid Submittal Checklist.....	2
Instructions to Bidders.....	3-6
General Conditions of Bidding and Terms of Contract.....	7-14
Special Requirements/Instructions	15-16
Procurement Standards.....	17-50
Davis-Bacon Prevailing Wage Rates	51-55
Vendor References	56
Certificate of Interested Parties Form 1295.....	57
Conflict of Interest Questionnaire.....	58
Specifications and Drawings	59-65
Bid Form	66
Signature Page	67
Offer and Acceptance Form	68

BID SUBMITTAL CHECKLIST

The items checked below represent components comprising this bid package. If the item **IS NOT** checked, it is **NOT APPLICABLE** to this bid. Bidders are asked to review the package to be sure that all applicable parts are included. If any portion of the package is missing, notify the Auditor's Office immediately.

It is the Bidder's responsibility to be thoroughly familiar with all Requirements and Specifications. Be sure you understand the following before you return your bid packet.

- 1. **Cover Sheet –**
- 2. **Table of Contents**
This page is the Table of Contents
- 3. **Offer and Acceptance Form**
This page to be sign and returned with Bid packet.
- 4. **General Requirements**
You should be familiar with all of the General Requirements.
- 5. **Special Requirements/Instructions**
Provides information you must know in order to make an offer properly.
- 6. **Specifications**
Contains the detailed description of the product/service sought by the County.
- 7. **Pricing/Delivery Information**
Used to solicit exact pricing of goods/services and delivery costs.
- 8. **Attachments**
 - a. **Bid Guaranty & Performance Bond Information & Requirements**
Applies only to certain bids/proposals. Read carefully and fill out completely.
 - b. **Bid Check Return Authorization Form**
Applies only to certain forms. Read carefully and fill out completely.
 - c. **Vehicle Delivery Instructions**
Included only when purchasing vehicles.
 - d. **Minimum Insurance Requirements**
Included when applicable (does not supersede "Hold Harmless" section of General Requirements).
 - e. **Workers' Compensation Insurance Coverage Rule 110.110**
Applicable for a building or construction contract.
 - f. **Financial Statement**
When this information is required, you must use this form.
 - g. **Reference Sheet**
 - h. **Other – From 1295 and Form CIQ**
From time to time other attachments may be included.

INSTRUCTIONS TO BIDDERS

1. Bid Submission

- A. Bids must be submitted in complete original form by mail or messenger to the following address:

Leon County Auditor's Office
PO Box 898
113 West Main Street, 2nd Floor
Centerville, Texas 75833

- B. Bids will be accepted at the above address until the time and date specified herein and will be publicly opened and read aloud the same day.
- C. All bids shall be tightly sealed in an envelope and plainly marked with the Invitation for Bid number, due date, and the bidder's name and address.
- D. Late bids will not be accepted and will be returned unopened to the bidder.
- E. All bids submitted in response to this invitation shall become the property of Leon County and will be a matter of public record available for review.

2. Preparation of Bids

- A. The bid shall be legibly printed in ink or typed.
- B. If a unit price or extension already entered is to be altered, it shall be crossed out and initialed in ink by the bidder.
- C. The bid shall be legally signed and shall include the complete address of the bidder.
- D. Leon County is exempt from Federal and State Sales Taxes, and such taxes shall not be included in bid prices.

3. Signatures

All bids, notifications, claims, and statements must be signed by an individual authorized to bind the bidder. The individual signing certifies, under penalty of perjury, that he or she has the legal authorization to bind the bidder.

4. Rejection or Withdrawal

Submission of additional terms, conditions or agreements with the bid document are grounds for deeming a bid non-responsive and may result in bid rejection. Leon County reserves the right to reject any and all bids and to waive any informalities and minor irregularities or defects in bids. Bids may be withdrawn in person by a bidder or authorized representative, provided their identity is made known and a receipt is signed for the bid, but only if the withdrawal is made prior to the time set for receipt of bids. Bids are an irrevocable offer and may not be withdrawn within 90 days after opening date.

5. Award

The bid will be awarded to the responsible, responsive bidder(s) whose bid, conforming to the solicitation, will be most advantageous to Leon County – price and other factors considered. Unless otherwise specified in this IFB, Leon County reserves the right to accept a bid in whole or in part, and to award by item or by group, whichever is deemed to be in the best interest of Leon County. Any bidder who is in default to Leon County at the time of submittal of the bid shall have that bid rejected. Leon County reserves the right to clarify any

contractual terms with the concurrence of the Contractor; however, any substantial nonconformity in the offer, as determined by Leon County, shall be deemed non-responsive and the offer rejected.

In evaluating bids, Leon County shall consider the qualifications of the bidders, and, where applicable, operating costs, delivery time, maintenance requirements, performance data, and guarantees of materials and equipment. In addition, Leon County may conduct such investigation as it deems necessary to assist in the evaluation of a bid and to establish the responsibility, qualifications, and financial ability of the bidders to fulfill the contract.

Leon County reserves the right to award this contract on the basis of **lowest and best bid** in accordance with the laws of the State of Texas, to waive any formality or irregularity, to make awards to more than one offeror, and/or to reject any or all bids. In the event the lowest dollar offeror meeting specifications is not an awarded contract, Offeror may appear before the Commissioners' Court and present evidence concerning Offeror responsibility after officially notifying the Auditor's Office of Offeror's intent to appear.

6. Contract

A response to an IFB is an offer to contract with Leon County based upon the terms, conditions, and specifications contained in the IFB. Bids do not become contracts unless and until they are executed by Leon County, eliminating a formal signing of a separate contract. For that reason, all of the terms and conditions of the contract are contained in the IFB, unless any of the terms and conditions is modified by an IFB Amendment, a Contract Amendment, or by mutually agreed terms and conditions in the contract documents.

7. Bid Results

Bid results are not provided in response to telephone inquiries. The final tabulation will be posted on the county website www.co.leon.tx.us after Commissioner's Court decision.

8. Changes and Addenda to Bid Documents

Each change or addendum issued in relation to this IFB document will be on file in the Auditor's Office. In addition, to the extent possible, copies will be mailed to each person registered as having received a set of bid documents. It shall be the bidder's responsibility to make inquiry as to change or addenda issued. All such changes or addenda shall become part of the contract and all bidders shall be bound by such addenda. Information on all changes or addenda issued will be available at the Auditor's Office.

9. Specifications

Unless otherwise stated by the bidder, the bid will be considered as being in accordance with Leon County's applicable standard specifications, and any special specifications outlined in the bid document. References to a particular trade name, manufacturer's catalogue, or model number are made for descriptive purposes to guide the bidder in interpreting the requirements of Leon County and should not be construed as excluding bids on other types of materials, equipment, and supplies. However, the bidder, if awarded a contract, will be required to furnish the particular item referred to in the specifications or description unless departure or substitution is clearly noted and described in the bid. Leon County reserves the right to determine if equipment/product being bid is an acceptable alternate. All goods shall be new unless otherwise so stated in the bid. Any unsolicited alternate bid, or any changes, insertions, or omissions to the terms and conditions, specifications, or any other requirements of the bid, may be considered non-responsive.

10. Delivery

Bids shall include all charges for delivery, packing, crating, containers, etc. Unless otherwise stated by the bidder, prices bid will be considered as being based on F.O.B. delivered, freight included.

11. Interpretation of Bid and/or Contract Documents

All inquiries shall be made within a reasonable time prior to the date and time fixed for the bid opening, in order that a written response in the form of an addendum, if required, can be processed before the bids are opened. Inquiries received that are not made in a timely fashion may or may not be considered.

12. Currency

Prices calculated by the bidder shall be stated in U.S. dollars.

13. Pricing

Prices shall be stated in units of quantity specified in the bid documents. In case of discrepancy in computing the amount of the bid, the unit price shall govern.

14. Notice to Proceed/Purchase Order

The successful bidder may not commence work under this contract until authorized to do so by the Leon County Auditor's Office.

15. HB 1295

By law, **vendor must complete a new Form 1295 for every contract** with the Texas Ethics Commission ("TEC"). The TEC website can be accessed at <http://www.ethics.state.tx.us/file/>. **Business entities MUST complete a new Form 1295 online prior to contracting with Leon County for every contract.** Upon completing the form, the TEC website will generate a PDF version of the business entity's Form 1295, including creating a unique "Certificate Number" for every contract that will be stamped in the upper right hand corner of the form. The business entity **must then sign a hard copy of the form and submit it to Leon County with the submitted bid documents.** **Failure to submit Form 1295 with bid documents will result in disqualification.** Example form can be found on Page 57.

16. Conflict of Interest Questionnaire

Vendor must complete a new Conflict of Interest (CIQ) Questionnaire for every contract if there is a conflict between the vendor and Leon County. A signed copy must be returned with the submitted bid documents. If there is no conflict, please notate such on the CIQ form and return with bid documents. This form can be accessed at <https://www.ethics.state.tx.us/forms/CIQ>. Example of this form can be found on Page 58.

17. Certification

By signing the offer section of the Offer and Acceptance page, bidder certifies:

- A. The submission of the offer did not involve collusion or other anti-competitive practices.
- B. The bidder has not given, offered to give, nor intends to give at any time hereafter, any economic opportunity, future employment, gift, loan, gratuity, special discount, trip, favor, or service to a public servant in connection with the submitted offer.

- C. The bidder hereby certifies that the individual signing the bid is an authorized agent for the bidder and has the authority to bind the bidder to the contract.

18. Definitions

“County” – Leon County, Texas.

“Contractor” – The bidder whose proposal is accepted by Leon County.

GENERAL TERMS AND CONDITIONS OF BIDDING AND TERMS OF CONTRACT

By execution of this document, the vendor accepts all general and special conditions of the contract as outlined below and, in the specifications and plans.

1. BIDDING

A. Bids

All bids must be submitted on the bid form furnished in this package.

B. Authorized Signatures

The bid must be executed personally by the vendor, duly authorized partner of the partnership, or duly authorized officer of the corporation. If executed by an agent, a power of attorney or other evidence of authority to act on behalf of the vendor shall accompany the bid to become a valid bid.

C. Late Bids

Bids must be in the Auditor's Office before or at the specified time and date bids are due. Bids received after the submission deadline shall be rejected as non-responsive.

D. Withdrawal of Bids Prior to Bid Opening

A bid may be withdrawn before the opening date by submitting a written request to the Auditor's Office. If time allows the bidder may submit a new bid. Bidder assumes full responsibility for submitting a new bid before or at the specified time and date bids are due. Leon County reserves the right to withdraw a request for bids before the opening date.

E. Withdrawal of Bids after Bid Opening

Bidder agrees that its offer may not be withdrawn or cancelled by the vendor for a period of ninety (90) days following the date and time designated for the receipt of bids unless otherwise stated in the bid and/or specifications.

F. Bid Amounts

Bids shall show net prices, extensions where applicable and net total. In case of conflict between unit price and extension, the unit price will govern. Any ambiguity in the bid as a result of omission, error, unintelligible or illegible wording shall be interpreted in the favor of Leon County.

G. Exceptions and/or Substitutions

All bids meeting the intent of the specifications and plans will be considered for award. Vendors taking exception to the specifications and plans, or offering substitutions, shall state these exceptions in the section provided. If bid is made on an article other than the one specified, which a bidder considers comparable, the name and grade of said article must be specified in the bid and sufficient specifications and descriptive data must accompany same to permit thorough evaluation. The absence of stated exceptions and/or substitutions shall indicate that the vendor has not taken any exceptions to the specifications and shall be responsible to perform in strict accordance

with the specifications. **As a matter of practice, Leon County rejects exception(s) and /or substitutions as non-responsive but reserves the right to accept any and/or all of the exception(s) and/or substitution(s) deemed to be in the best interest of Leon County.**

H. Alternates

The Invitation for Bid and/or specifications may expressly allow bidder to submit an alternate bid. Presence of such an offer shall not be considered an indication of non-responsiveness.

I. Descriptions

Unless otherwise specified, any reference to make, manufacturer and/or model used in the bid specifications is merely descriptive and not restrictive, and is used only to indicate type, style, or quality of material desired.

J. Bid Alterations

Bids cannot be altered or amended after submission deadline. Any interlineations, alterations, or erasures made before opening time must be initialed by the signer of the bid, guaranteeing authenticity.

K. Tax Exempt Status

Leon County is exempt from federal excise tax and state sales tax. Unless the bid form or specifications specifically indicate otherwise, the bid price must be net, exclusive of above-mentioned taxes and will be so construed. Therefore, the bid price shall not include taxes.

L. Quantities

Quantities indicated are estimated quantities only and are not a commitment to buy. Approximate usage does not constitute an order, but only implies the probable quantity that will be used. Commodities will be ordered on an as-needed basis. Bidder is responsible for accurate final counts.

M. Bid Award

Award of contract shall be made to the most responsible, responsive bidder, whose offer is determined to be the best value, taking into consideration the relative importance of price. Leon County reserves the right to be the sole judge as to whether items bid will serve the purpose intended. Leon County reserves the right to accept or reject in part or in whole any bid submitted, and to waive any technicalities or informalities for the best interest of the County. Leon County reserves the right to award based upon individual line items, sections, or total bid.

N. Silence of Specifications for Complete Units

All materials, equipment and/or parts that will become a portion of the completed work, including items not specifically stated herein but, necessary to render the service(s) complete and operational per the specifications, are to be included in the bid price. Vendor may be required to furnish evidence that the service, as bid, will meet or exceed these requirements.

O. Addenda

Any interpretations, corrections or changes to the specifications and plans will be made by addenda no later than forty-eight (48) hours prior to the bid opening. Addenda will be distributed to all known recipients of bid documents. Vendors shall acknowledge receipt of all addenda with submission of bid.

P. General Bid Bond/Surety Requirements

Failure to furnish bid bond/surety, if requested, will result in bid being declared non-responsive. Non-responsive bids will not be considered for award.

Q. General Insurance Requirements

Failure to furnish Affidavit of Insurance, if required in these specifications, will result in bid being declared non-responsive. Non-responsive bids will not be considered for award.

R. Responsiveness

A responsive bid shall substantially conform to the requirements of this Invitation to Bid and/or specifications contained herein. Bidders who substitute any other terms, conditions, specifications and/or requirements or who qualify their bids in such a manner as to nullify or limit their liability to the contracting entity shall have their bids deemed non-responsive. Also, bids containing any clause that would limit contracting authority shall be considered non-responsive. Examples of non-responsive bids include but shall not be limited to a) bids that fail to conform to required delivery schedules as set forth in the bid request; b) bids with prices qualified in such a manner that the bid price cannot be determined, such as with vague wording that may include "price in effect at the time of delivery," and c) bids made contingent upon award of other bids currently under consideration.

S. Responsible Standing of Bidder

To be considered for award, bidder must at least: have the ability to obtain adequate financial resources, be able to comply with required or proposed delivery/completion schedule, have a satisfactory record of performance; have a satisfactory record of integrity and ethics, and be otherwise qualified and eligible to receive award.

T. Proprietary Data

Bidder may, by written request, indicate as confidential any portion(s) of a bid that contain proprietary information, including manufacturing and/or design processes exclusive to the vendor. Leon County will protect from public disclosure such portions of a bid, unless directed otherwise by legal authority, including existing Open Records Acts.

U. Public Bid Opening

Bidders are invited to be present at the opening of bids. After the official opening of bids, a period of not less than one week is necessary to evaluate bids. The amount of time necessary for bid evaluation may vary and is determined solely by the County. Following the bid evaluation, all bids submitted are available for public review.

2. PERFORMANCE

A. Design, Strength, and Quality

Design, strength, and quality of materials and workmanship must conform to the highest standards of manufacturing and engineering practices. The apparent silence of specifications and/or plans as to any detailed description concerning any point shall be regarded as meaning that only the best commercial practices are to prevail. All interpretations of these specifications and/or plans shall be made on the basis of this statement.

B. Age and Manufacture

All tangible goods being bid must be new and unused, unless otherwise specified, in first-class condition, of current manufacture, and furnished ready to use. All items not specifically mentioned that are required for a complete unit shall be furnished.

C. Delivery Location

All deliveries will be made to the address(es) specified on the purchase order during working hours of 8:00 a.m. to 3:00 p.m., Monday through Friday, unless otherwise authorized by the Leon County Auditor's Office or designee.

D. Delivery Schedule

Delivery time may be an important consideration in the evaluation of best value. The maximum number of days necessary for delivery ARO shall be stated in the space, if provided, on the bid form.

E. Delivery Charges

All delivery and freight charges, F.O.B. destination shown on Leon County purchase order, as necessary to perform contract are to be included in the bid price.

F. Installation Charges

All charges for assembly, installation and set-up shall be included in the bid price. Unless otherwise stated, assembly, installation and set-up will be required.

G. Operating Instructions and Training

Clear and concise operating instructions and descriptive literature will be provided in English, if requested. On-site detailed training in the safe and efficient use and general maintenance of item(s) purchased shall be provided as needed at the request of Leon County. Instructions and training shall be at no additional cost to the County.

H. Storage

Bidder agrees to provide storage of custom ordered materials, if requested, for up to thirty (30) calendar days.

I. Compliance with Federal, State, County, and Local Laws

Bids must comply with all federal, state, county, and local laws, including, but not limited to, all applicable standard safety, emission, and noise control requirements. Any vehicles or equipment shall contain all standard safety, emission, and noise control requirements required for the types and sizes of equipment at the time of their manufacture. The contractor agrees, during the performance of work or service, to

comply with all applicable codes and ordinances of Leon County or the State of Texas as they may apply, as these laws may now read, or as they may hereafter be changed or amended.

J. OSHA

The bidder will certify all equipment complies with all regulations and conditions stipulated under the Williams-Steiger Occupational Safety and Health Act of 1971, as amended. The successful bidder will further certify that all items furnished under this project will conform and comply with federal and State of Texas OSHA standards. The successful bidder will agree to indemnify and hold harmless Leon County for any and all damages that may be assessed against the County.

K. Patents and Copyrights

The successful vendor agrees to protect the County from claims involving infringements of patents and/or copyrights.

L. Samples, Demonstrations and Testing

At Leon County's request and direction, bidder shall provide product samples and/or testing of items bid to ensure compliance with specifications. Samples, demonstrations and/or testing may be requested at any point prior to or following bid award. Samples, demonstrations and/or testing may be requested upon delivery and/or any point during the term of resulting contract. All samples (including return thereof), demonstrations, and/or testing shall be at the expense of the bidder/vendor.

M. Acceptability

All articles enumerated in the bid shall be subject to inspection by an officer designated for that purpose by Leon County. If found inferior to the quality called for, or not equal in value to the specifications, deficient in workmanship or otherwise, this fact shall be certified to the Leon County Auditor's Office, who shall have the right to reject the whole or any part of the same. Items and/or work determined to be contrary to specifications must be replaced at the vendor's expense. Inferior items not retrieved by the vendor within thirty (30) calendar days or an otherwise agreed upon time, shall become the property of the County. If disposal of such items warrants an expense, an amount equal to the disposal expense will be deducted from amounts payable to the vendor.

3. PURCHASE ORDERS AND PAYMENT

A. Purchase Orders

A purchase order(s) shall be generated by the Leon County Auditor's Office to the successful vendor. The purchase order number must appear on all itemized invoices and packing slips. The County will not be held responsible for any work orders placed and/or performed without a valid current purchase order number. Payment will be made for all services rendered and accepted by the contract administrator for which a valid invoice has been received.

B. Invoices

All invoices shall reference the Purchase Order number. Invoices shall reference the bid item number or a detailed description for each item invoiced. If an item purchased and itemized on the invoice does not correspond to an item in any of the categories awarded to the vendor, invoice shall reference the item as "N/C" to indicate that it is a

non-contract item. This requirement is to assist the County in verifying contract pricing on all invoices. Payment will be made under terms of net thirty (30) days. All invoices shall be mailed to the Leon County Auditor's Office, PO Box 898, Centerville, Texas 75833.

C. Funding

Leon County is operated and funded on an October 1 to September 30 basis; accordingly, the County reserves the right to terminate, without liability to the County, any contract for which funding is not available.

D. Audit Provision

Seller shall establish a reasonable accounting system, which enables ready identification of seller's cost of goods and use of funds. Buyer may audit seller's records any time before three years after final payment to verify buyer's payment obligation and use of buyer's funds. This right to audit shall include subcontractors in which goods or services are subcontracted by seller. Seller shall insure buyer has these rights with subcontractor(s).

4. CONTRACT

A. Contract Definition

The General Conditions of Bidding and Terms of Contract, Specifications, Plans, Bidding Forms, Addenda, and any other documents made a part of this bid shall constitute the complete bid. This bid, when duly accepted by Leon County, shall constitute a contract equally binding between the successful bidder and Leon County.

B. Contract Agreement

Once a contract is awarded, the unit prices offered by the successful bidder shall remain firm for the term of the contract. Contract shall commence on date of award.

C. Change Order

No different or additional terms will become part of this contract with the exception of a change order. No oral statement of any person shall modify or otherwise change, or affect the terms, conditions or specifications stated in the resulting contract. All change orders to the contract will be made in writing and at the discretion and approval of Leon County. No change order will be binding unless signed by an authorized representative of the County and the vendor.

D. Escalation Clause

The contract price is payable in the currency stated in "Instruction to Bidders, Section 13" and the contract price and any rates included in the contract shall be fixed and shall not be subject to any increase as a result of any fluctuation, escalation and/or increase in the contractor's costs or otherwise and/or any change in currency exchange rates.

E. Price Redetermination

A price redetermination may be considered by Leon County only at the twelve (12) month anniversary dates of the contract, if applicable. All requests for a price redetermination shall be in written form. Cause for such request, i.e., manufacturer's direct cost, postage rates, Railroad Commission rates, Federal/ State minimum wage law, Federal/State unemployment taxes, F.I.C.A, Insurance Coverage Rates, etc., shall be substantiated in writing by the source of the cost increase. The bidder's past experience of honoring contracts at the bid price will be an important consideration in

the evaluation of the lowest and best bid. Leon County reserves the right to accept or reject any/all requests for price redetermination as it deems to be in the best interest of the County.

F. Termination for Default

Leon County reserves the right to enforce the performance of this contract in any manner prescribed by law or deemed to be in the best interest of the County in the event of breach or default of this contract. Leon County reserves the right to terminate the contract immediately in the event the vendor fails to perform to the terms of specifications or fails to comply with the terms of this contract. Breach of contract or default authorizes the County to award to another vendor, purchase elsewhere, and charge the full increase in cost and handling to the defaulting party.

G. Invalid, Illegal, or Unenforceable Provisions

In case any one or more of the provisions contained in the Contract shall for any reason be held to be invalid, illegal, or unenforceable in any respect, such invalidity, illegality, or unenforceability shall not affect any other provision thereof and this contract shall be considered as if such invalid, illegal, or unenforceable provision had never been contained herein.

H. Injuries or Damages Resulting from Negligence

Successful vendor shall defend, indemnify and save harmless Leon County and all its officers, agents and employees from all suits, actions, or other claims of any character, name and description brought for or on account of any injuries or damages received or sustained by any person, persons, or property on account of any negligent act or fault of the successful vendor, or of any agent, employee, subcontractor or supplier in the execution of, or performance under, any contract which may result from bid award. Successful vendor shall pay any judgment with cost which may be obtained against Leon County growing out of such injury or damages.

I. Interest by Public Officials

No public official shall have interest in this contract, in accordance with Texas local government code.

J. Warranty

The successful vendor shall warrant that all materials utilized in the performance of this contract shall conform to the proposed specifications and/or all warranties as stated in the Uniform Commercial Code and be free from all defects in material, workmanship, and title.

K. Uniform Commercial Code

The successful vendor and Leon County agree that both parties have all rights, duties, and remedies available as stated in the Uniform Commercial Code.

L. Venue

This agreement will be governed and construed according to the laws of the State of Texas. This agreement is performable in the County of Leon, Texas.

M. Sale, Assignment, or Transfer of Contract

The successful vendor shall not sell, assign, transfer or convey this contract, in whole or in part, without the prior written consent of Leon County.

N. Silence of Specifications

The apparent silence of these specifications as to any detailed description concerning any point, shall be regarded as meaning that only the best commercial practices are to prevail. All interpretations of these specifications shall be made on the basis of this statement.

SPECIAL REQUIREMENTS/INSTRUCTIONS

The following requirements and instructions supersede General Requirements where applicable.

1. Bid Requirement

Each bidder should submit as a bid this entire IFB, completed where necessary, for example, the IFB cover sheet, the Price Sheets, etc. Use an opaque envelope, clearly indicating on the outside the Job Number, Job Description, and marked "SEALED BID". Leon County shall not be responsible for any effort or cost expended in the preparation of a response to this IFB. All protests should be coordinated through the Auditor's Office prior to award recommendation to Commissioners' Court.

2. Delivery Time

Bid shall show number of days in advance required to place aggregate services at the County's designated locations. Failure to state delivery time may cause bid to be rejected. The county has the right to extend delivery time if reason appears valid.

3. Payment

Leon County will pay original invoices that clearly itemize the goods and/or services provided as to quantity, part number, description, price, applicable discount (if any), labor charges showing time differential, if applicable and if previously agreed to, and delivery, installation, and set-up costs, if applicable and if previously agreed to. Only charges as stated on the Bid Form(s) submitted as a part of the bid will be considered.

Invoices must indicate Leon County as applicable, the address to which the product(s) and/or service(s) were delivered, and the applicable purchase order number. Invoices will be matched to delivery tickets prior to payment; therefore, all delivery tickets should have an accurate description of the product(s) and/or service(s).

4. Minimum Insurance Requirements

- A. The contractor shall, at all times during the term of this contract, maintain insurance coverage with not less than the type and requirements shown below. Such insurance is to be provided at the sole cost of the contractor. These requirements do not establish limits of the contractor's liability.
- B. All policies of insurance shall waive all rights of subrogation against the County, its officers, employees, and agents.
- C. Successful bidder shall be required, at his or her own expense, to furnish the Leon County Auditor's Office within ten (10) days of notification of award with certified copies of all insurance policies or certificates of insurance for General Liability, Workers Compensation, and Vehicle insurance coverage to be in force throughout the term of the contract. Leon County shall be named as an additional "INSURED". All insurance shall be in accordance with the governing federal, state, or local laws.
- D. The County reserves the right to require additional insurance should it deem necessary.
- E. Workers' Compensation (with Waiver of subrogation to Leon County) Employer's Liability, including all states, and other endorsements, if applicable to the Project.

Statutory, and Bodily Injury by Accident: \$100,000 each employee. Bodily Injury by Disease: \$500,000 policy limit \$100,000 each employee. Leon County shall be named as "additional insured" on workers' compensation policy.

- F. Commercial General Liability Occurrence Form including, but not limited to, Premises and Operations, Products Liability Broad Form Property Damage, Contractual Liability, Personal and Advertising Injury Liability and where the exposure exists, coverage for watercraft, blasting collapse, and explosions, blowout, cratering and underground damage.

\$500,000 each occurrence Limit Bodily Injury and Property Damage Combined \$500,000 Products-Completed Operations Aggregate Limit \$500,000 Per Job Aggregate \$500,000 Personal and Advertising Injury Limit. Leon County shall be named as "additional insured" on commercial general liability policy.

- G. Automobile Liability Coverage: \$300,000 Combined Liability Limits. Bodily Injury and Property Damage Combined. Leon County shall be named as "additional insured" on automobile policy.

5. Price Reduction

If during the life of the contract, the successful bidder's net prices to other customers for hauling of aggregate awarded herein are reduced below the contracted prices, it is understood and agreed that the benefits of such reduction shall be extended to Leon County.

6. Exceptions/Substitutions

All bids meeting the intent of this bid will be considered for award. Bidders taking exception to the specifications, or offering substitutions, shall state these exceptions in the section provided or by attachment as part of the bid. The absence of such a list shall indicate that the bidder has not taken exceptions and shall hold the bidder responsible to perform in strict accordance with the specifications of the bid. Leon County Commissioners Court reserves the right to accept any/or all/none of the exception(s)/substitution(s) deemed to be in the best interest of the County.

Federally Funded Contracts Procurement Standards and Associated Matters

The County of Leon follows the procurement standards in 2 CFR 200.317 – 2CFR 200.327 and Appendix II to Part 200 for procurement actions to be funded with Federal funds. All attempts are made to adhere to these policies and procedures and updates are made as needed. The entirety of the language found in 2 CFR 200.317 – 2 CFR 200.327 may not be applicable in all instances, programs, and/or situations. This document contains the most current 2 CFR 200.317 – 2 CFR 200.327 language available at the adoption of these policies and procedures.

9.1 General Procurement Standards

Depending on the specific funding source of the procurement request, solicitation efforts by Leon County utilizing Federal funding are subject to additional procurement standards. 2 CFR PART 200 - UNIFORM ADMINISTRATIVE REQUIREMENTS, COST PRINCIPLES, AND AUDIT REQUIREMENTS FOR FEDERAL AWARDS, and 24 CFR 85.36 - PROCUREMENT (U.S. DEPARTMENT OF HOUSING AND URBAN DEVELOPMENT (HUD) affect or may affect procurement requirements and mandate various contract terms. The foregoing listing is not exhaustive.

Special Note: As well relevant procurement standards on previous disaster recovery assistance projects may be found at 44 C.F.R. 13.36 (a)-(i) (States, local, and tribal governments), or other sources.

Procedures for Federally funded solicitations must include all required Federal clauses and language.

9.2 Sections 2 C.F.R. §§ 200.317- 200.326

These sections impose requirements for federally funded contracts across a broad range of granting agencies. The County, a non-Federal entity and generally a subrecipient in these grant programs, is subject to these requirements. Sections 200.318 through 200.326, as such regulations exist on the date of the Auditor's Office adoption of these policies, follow:

§200.317 Procurements by states

When procuring property and services under a Federal award, a State must follow the same policies and procedures it uses for procurements from its non-Federal funds. The State will comply with §§200.321, 200.322, and 200.323 and ensure that every purchase order or other contract includes any clauses required by §200.327. All other non-Federal entities, including subrecipients of a State, must follow the procurement standards in §§200.318 through 200.327.

§200.318 General procurement standards

- (a) The non-Federal entity must have and use documented procurement procedures, consistent with State, local, and tribal laws and regulations and the standards of this section, for the acquisition of property or services required under a Federal award or subaward. The non-Federal entity's documented procurement procedures must conform to the procurement standards identified in §§200.317 through 200.327.
- (b) Non-Federal entities must maintain oversight to ensure that contractors perform in accordance with the terms, conditions, and specifications of their contracts or purchase orders.
- (c)(1) The non-Federal entity must maintain written standards of conduct covering conflicts of interest and governing the actions of its employees engaged in the selection, award, and administration of contracts. No employee, officer, or agent may participate in the selection, award, or administration of a contract supported by a Federal award if he or she has a real

or apparent conflict of interest. Such a conflict of interest would arise when the employee, officer, or agent, any member of his or her immediate family, his or her partner, or an organization which employs or is about to employ any of the parties indicated herein, has a financial or other interest in or a tangible personal benefit from a firm considered for a contract. The officers, employees, and agents of the non-Federal entity may neither solicit nor accept gratuities, favors, or anything of monetary value from contractors or parties to subcontracts. However, non-Federal entities may set standards for situations in which the financial interest is not substantial, or the gift is an unsolicited item of nominal value. The standards of conduct must provide for disciplinary actions to be applied for violations of such standards by officers, employees, or agents of the non-Federal entity.

(2) If the non-Federal entity has a parent, affiliate, or subsidiary organization that is not a State, local government, or Indian tribe, the non-Federal entity must also maintain written standards of conduct covering organizational conflicts of interest.

Organizational conflicts of interest means that because of relationships with a parent company, affiliate, or subsidiary organization, the non-Federal entity is unable or appears to be unable to be impartial in conducting a procurement action involving a related organization.

- (d) The non-Federal entity's procedures must avoid acquisition of unnecessary or duplicative items. Consideration should be given to consolidating or breaking out procurements to obtain a more economical purchase. Where appropriate, an analysis will be made of lease versus purchase alternatives, and any other appropriate analysis to determine the most economical approach.
- (e) To foster greater economy and efficiency, and in accordance with efforts to promote cost-effective use of shared services across the Federal Government, the non-Federal entity is encouraged to enter into state and local intergovernmental agreements or inter-entity agreements where appropriate for procurement or use of common or shared goods and services. Competition requirements will be met with documented procurement actions using strategic sourcing, shared services, and other similar procurement arrangements.
- (f) The non-Federal entity is encouraged to use Federal excess and surplus property in lieu of purchasing new equipment and property whenever such use is feasible and reduces project costs.
- (g) The non-Federal entity is encouraged to use value engineering clauses in contracts for construction projects of sufficient size to offer reasonable opportunities for cost reductions. Value engineering is a systematic and creative analysis of each contract item or task to ensure that its essential function is provided at the overall lower cost.
- (h) The non-Federal entity must award contracts only to responsible contractors possessing the ability to perform successfully under the terms and conditions of a proposed procurement. Consideration will be given to such matters as contractor integrity, compliance with public policy, record of past performance, and financial and technical resources. See also §200.214.
- (i) The non-Federal entity must maintain records sufficient to detail the history of procurement. These records will include, but are not necessarily limited to, the following: Rationale for the method of procurement, selection of contract type, contractor selection or rejection, and the basis for the contract price.
- (j)(1) The non-Federal entity may use a time-and-materials type contract only after a determination that no other contract is suitable and if the contract includes a ceiling price that the contractor exceeds at its own risk. Time-and-materials type contract means a contract whose cost to a non-Federal entity is the sum of:
 - (i) The actual cost of materials; and
 - (ii) Direct labor hours charged at fixed hourly rates that reflect wages, general and administrative expenses, and profit.
- (2) Since this formula generates an open-ended contract price, a time-and-materials contract provides no positive profit incentive to the contractor for cost control or labor efficiency. Therefore, each contract must set a ceiling price that the contractor exceeds at its own risk. Further, the non-Federal entity awarding such a contract

must assert a high degree of oversight in order to obtain reasonable assurance that the contractor is using efficient methods and effective cost controls.

- (k) The non-Federal entity alone must be responsible, in accordance with good administrative practice and sound business judgment, for the settlement of all contractual and administrative issues arising out of procurements. These issues include, but are not limited to, source evaluation, protests, disputes, and claims. These standards do not relieve the non-Federal entity of any contractual responsibilities under its contracts. The Federal awarding agency will not substitute its judgment for that of the non-Federal entity unless the matter is primarily a Federal concern. Violations of law will be referred to the local, state, or Federal authority having proper jurisdiction.

[85 FR 49543, Aug. 13, 2020, as amended at 86 FR 10440, Feb. 22, 2021]

§200.319 Competition

- (a) All procurement transactions for the acquisition of property or services required under a Federal award must be conducted in a manner providing full and open competition consistent with the standards of this section and §200.320.
- (b) In order to ensure objective contractor performance and eliminate unfair competitive advantage, contractors that develop or draft specifications, requirements, statements of work, or invitations for bids or requests for proposals must be excluded from competing for such procurements. Some of the situations considered to be restrictive of competition include but are not limited to:
 - (1) Placing unreasonable requirements on firms in order for them to qualify to do business;
 - (2) Requiring unnecessary experience and excessive bonding;
 - (3) Noncompetitive pricing practices between firms or between affiliated companies;
 - (4) Noncompetitive contracts to consultants that are on retainer contracts;
 - (5) Organizational conflicts of interest;
 - (6) Specifying only a “brand name” product instead of allowing “an equal” product to be offered and describing the performance or other relevant requirements of the procurement; and
 - (7) Any arbitrary action in the procurement process.
- (c) The non-Federal entity must conduct procurements in a manner that prohibits the use of statutorily or administratively imposed state, local, or tribal geographical preferences in the evaluation of bids or proposals, except in those cases where applicable Federal statutes expressly mandate or encourage geographic preference. Nothing in this section preempts state licensing laws. When contracting for architectural and engineering (A/E) services, geographic location may be a selection criterion provided its application leaves an appropriate number of qualified firms, given the nature and size of the project, to compete for the contract.
- (d) The non-Federal entity must have written procedures for procurement transactions. These procedures must ensure that all solicitations:
 - (1) Incorporate a clear and accurate description of the technical requirements for the material, product, or service to be procured. Such description must not, in competitive procurements, contain features which unduly restrict competition. The description may include a statement of the qualitative nature of the material, product, or service to be procured and, when necessary, must set forth those minimum essential characteristics and standards to which it must conform if it is to satisfy its intended use. Detailed product specifications should be avoided if at all possible. When it is impractical or uneconomical to make a clear and accurate description of the technical requirements, a “brand name or equivalent” description may be used as a means to define the performance or other salient requirements of procurement. The specific features of the named brand which must be met by offers must be clearly stated; and

- (2) Identify all requirements which the offerors must fulfill and all other factors to be used in evaluating bids or proposals.
- (e) The non-Federal entity must ensure that all prequalified lists of persons, firms, or products which are used in acquiring goods and services are current and include enough qualified sources to ensure maximum open and free competition. Also, the non-Federal entity must not preclude potential bidders from qualifying during the solicitation period.
- (f) Noncompetitive procurements can only be awarded in accordance with §200.320(c).

§200.320 Methods of procurement to be followed

The non-Federal entity must have and use documented procurement procedures, consistent with the standards of this section and §§200.317, 200.318, and 200.319 for any of the following methods of procurement used for the acquisition of property or services required under a Federal award or sub-award.

- (a) Informal procurement methods. When the value of the procurement for property or services under a Federal award does not exceed the simplified acquisition threshold (SAT), as defined in §200.1, or a lower threshold established by a non-Federal entity, formal procurement methods are not required. The non-Federal entity may use informal procurement methods to expedite the completion of its transactions and minimize the associated administrative burden and cost. The informal methods used for procurement of property or services at or below the SAT include:

- (1) Micro-purchases

- (i) Distribution. The acquisition of supplies or services, the aggregate dollar amount of which does not exceed the micro-purchase threshold (See the definition of micro-purchase in §200.1). To the maximum extent practicable, the non-Federal entity should distribute micro-purchases equitably among qualified suppliers.
- (ii) Micro-purchase awards. Micro-purchases may be awarded without soliciting competitive price or rate quotations if the non-Federal entity considers the price to be reasonable based on research, experience, purchase history or other information and documents it files accordingly. Purchase cards can be used for micro-purchases if procedures are documented and approved by the non-Federal entity.
- (iii) Micro-purchase thresholds. The non-Federal entity is responsible for determining and documenting an appropriate micro-purchase threshold based on internal controls, an evaluation of risk, and its documented procurement procedures. The micro-purchase threshold used by the non-Federal entity must be authorized or not prohibited under State, local, or tribal laws or regulations. Non-Federal entities may establish a threshold higher than the Federal threshold established in the Federal Acquisition Regulations (FAR) (<https://www.ecfr.gov/current/title-48/chapter-1/subchapter-A/part-2/subpart-2.1>) in accordance with paragraphs (a)(1)(iv) and (v) of this section.
- (iv) Non-Federal entity increases to the micro-purchase threshold up to \$50,000. Non-Federal entities may establish a threshold higher than the micro-purchase threshold identified in the FAR in accordance with the requirements of this section. The non-Federal entity may self-certify a threshold up to \$50,000 on an annual basis and must maintain documentation to be made available to the Federal awarding agency and auditors in accordance with §200.334. The self-certification must include a justification, clear identification of the threshold, and supporting documentation of any of the following:

- (a) A qualification as a low-risk auditee, in accordance with the criteria in §200.520 for the most recent audit;
- (b) An annual internal institutional risk assessment to identify, mitigate, and manage financial risks; or,

- (c) For public institutions, a higher threshold consistent with State law.
 - (v) Non-Federal entity increases to the micro-purchase threshold over \$50,000. Micro-purchase thresholds higher than \$50,000 must be approved by the cognizant agency for indirect costs. The non-federal entity must submit a request with the requirements included in paragraph (a)(1)(iv) of this section. The increased threshold is valid until there is a change in status in which the justification was approved.
- (2) Small purchases
 - (i) Small purchase procedures. The acquisition of property or services, the aggregate dollar amount of which is higher than the micro-purchase threshold but does not exceed the simplified acquisition threshold. If small purchase procedures are used, price or rate quotations must be obtained from an adequate number of qualified sources as determined appropriate by the non-Federal entity.
 - (ii) Simplified acquisition thresholds. The non-Federal entity is responsible for determining an appropriate simplified acquisition threshold based on internal controls, an evaluation of risk and its documented procurement procedures which must not exceed the threshold established in the FAR. When applicable, a lower simplified acquisition threshold used by the non-Federal entity must be authorized or not prohibited under State, local, or tribal laws or regulations.
- (b) Formal procurement methods. When the value of the procurement for property or services under a Federal financial assistance award exceeds the SAT, or a lower threshold established by a non-Federal entity, formal procurement methods are required. Formal procurement methods require following documented procedures. Formal procurement methods also require public advertising unless a non-competitive procurement can be used in accordance with §200.319 or paragraph (c) of this section. The following formal methods of procurement are used for procurement of property or services above the simplified acquisition threshold or a value below the simplified acquisition threshold the non-Federal entity determines to be appropriate:
 - (1) Sealed bids. A procurement method in which bids are publicly solicited and a firm fixed-price contract (lump sum or unit price) is awarded to the responsible bidder whose bid, conforming with all the material terms and conditions of the invitation for bids, is the lowest in price. The sealed bids method is the preferred method for procuring construction if the conditions meet the following criterion:
 - (i) In order for sealed bidding to be feasible, the following conditions should be present:
 - (a) A complete, adequate, and realistic specification or purchase description is available;
 - (b) Two or more responsible bidders are willing and able to compete effectively for the business; and
 - (c) The procurement lends itself to a firm fixed price contract and the selection of the successful bidder can be made principally on the basis of price.
 - (ii) If sealed bids are used, the following requirements apply:
 - (a) Bids must be solicited from an adequate number of qualified sources, providing them sufficient response time prior to the date set for opening the bids, for local, and tribal governments, the invitation for bids must be publicly advertised;
 - (b) The invitation for bids, which will include any specifications and pertinent attachments, must define the items or services in order for the bidder to properly respond;
 - (c) All bids will be opened at the time and place prescribed in the invitation for bids, and for local and tribal governments, the bids must be opened publicly;
 - (d) A firm fixed price contract award will be made in writing to the lowest responsive and responsible bidder. Where specified in bidding documents, factors such as discounts, transportation cost, and life cycle costs must be considered in determining which bid is

- lowest. Payment discounts will only be used to determine the low bid when prior experience indicates that such discounts are usually taken advantage of; and
- (e) Any or all bids may be rejected if there is a sound documented reason.
- (2) Proposals. A procurement method in which either a fixed price or cost-reimbursement type contract is awarded. Proposals are generally used when conditions are not appropriate for the use of sealed bids. They are awarded in accordance with the following requirements:
- (i) Requests for proposals must be publicized and identify all evaluation factors and their relative importance. Proposals must be solicited from an adequate number of qualified offerors. Any response to publicized requests for proposals must be considered to the maximum extent practical;
 - (ii) The non-Federal entity must have a written method for conducting technical evaluations of the proposals received and making selections;
 - (iii) Contracts must be awarded to the responsible offeror whose proposal is most advantageous to the non-Federal entity, with price and other factors considered; and
 - (iv) The non-Federal entity may use competitive proposal procedures for qualifications-based procurement of architectural/engineering (A/E) professional services whereby offeror's qualifications are evaluated, and the most qualified offeror is selected, subject to negotiation of fair and reasonable compensation. The method, where price is not used as a selection factor, can only be used in procurement of A/E professional services. It cannot be used to purchase other types of services though A/E firms that are a potential source to perform the proposed effort.
- (d) Noncompetitive procurement. There are specific circumstances in which noncompetitive procurement can be used. Noncompetitive procurement can only be awarded if one or more of the following circumstances apply:
- (1) The acquisition of property or services, the aggregate dollar amount of which does not exceed the micro-purchase threshold (see paragraph (a)(1) of this section);
 - (2) The item is available only from a single source;
 - (3) The public exigency or emergency for the requirement will not permit a delay resulting from publicizing a competitive solicitation;
 - (4) The Federal awarding agency or pass-through entity expressly authorizes a noncompetitive procurement in response to a written request from the non-Federal entity; or
 - (5) After solicitation of a number of sources, competition is determined inadequate.

§200.321 Contracting with small and minority businesses, women's business enterprises, and labor surplus area firms

- (a) The non-Federal entity must take all necessary affirmative steps to assure that minority businesses, women's business enterprises, and labor surplus area firms are used when possible.
- (b) Affirmative steps must include:
- (1) Placing qualified small and minority businesses and women's business enterprises on solicitation lists;
 - (2) Assuring that small and minority businesses, and women's business enterprises are solicited whenever they are potential sources;
 - (3) Dividing total requirements, when economically feasible, into smaller tasks or quantities to permit maximum participation by small and minority businesses, and women's business enterprises;
 - (4) Establishing delivery schedules, where the requirement permits, which encourage participation by small and minority businesses, and women's business enterprises;

- (5) Using the services and assistance, as appropriate, of such organizations as the Small Business Administration and the Minority Business Development Agency of the Department of Commerce; and
- (6) Requiring the prime contractor, if subcontracts are to be let, to take the affirmative steps listed in paragraphs (b)(1) through (5) of this section.³

§200.322 Domestic preferences for procurements

- (a) As appropriate and to the extent consistent with law, the non-Federal entity should, to the greatest extent practicable under a Federal award, provide a preference for the purchase, acquisition, or use of goods, products, or materials produced in the United States (including but not limited to iron, aluminum, steel, cement, and other manufactured products). The requirements of this section must be included in all subawards including all contracts and purchase orders for work or products under this award.
- (b) For purposes of this section:
 - (1) “Produced in the United States” means, for iron and steel products, that all manufacturing processes, from the initial melting stage through the application of coatings, occurred in the United States.
 - (2) “Manufactured products” means items and construction materials composed in whole or in part of non-ferrous metals such as aluminum; plastics and polymer-based products such as polyvinyl chloride pipe; aggregates such as concrete; glass, including optical fiber; and lumber.

§200.323 Procurement of recovered materials

A non-Federal entity that is a state agency or agency of a political subdivision of a state and its contractors must comply with section 6002 of the Solid Waste Disposal Act, as amended by the Resource Conservation and Recovery Act. The requirements of Section 6002 include procuring only items designated in guidelines of the Environmental Protection Agency (EPA) at 40 CFR part 247 that contain the highest percentage of recovered materials practicable, consistent with maintaining a satisfactory level of competition, where the purchase price of the item exceeds \$10,000 or the value of the quantity acquired during the preceding fiscal year exceeded \$10,000; procuring solid waste management services in a manner that maximizes energy and resource recovery; and establishing an affirmative procurement program for procurement of recovered materials identified in the EPA guidelines.

§200.324 Contract cost and price

- (a) The non-Federal entity must perform a cost or price analysis in connection with every procurement action in excess of the Simplified Acquisition Threshold including contract modifications. The method and degree of analysis is dependent on the facts surrounding the particular procurement situation, but as a starting point, the non-Federal entity must make independent estimates before receiving bids or proposals.
- (b) The non-Federal entity must negotiate profit as a separate element of the price for each contract in which there is no price competition and, in all cases, where cost analysis is performed. To establish a fair and reasonable profit, consideration must be given to the complexity of the work to be performed, the risk borne by the contractor, the contractor's investment, the amount of subcontracting, the quality of its record of past performance, and industry profit rates in the surrounding geographical area for similar work.
- (c) Costs or prices based on estimated costs for contracts under the Federal award are allowable only to the extent that costs incurred, or cost estimates included in negotiated prices would be allowable for the non-Federal entity under subpart E of this part. The non-Federal entity may reference its own cost principles that comply with the Federal cost principles.
- (d) The cost plus a percentage of cost and percentage of construction cost methods of contracting must not be used.

§200.325 Federal awarding agency or pass-through entity review

- (a) The non-Federal entity must make available, upon request of the Federal awarding agency or pass-through entity, technical specifications on proposed procurements where the Federal awarding agency or pass-through entity believes such review is needed to ensure that the item or service specified is the one being proposed for acquisition. This review generally will take place prior to the time the specification is incorporated into a solicitation document. However, if the non-Federal entity desires to have the review accomplished after a solicitation has been developed, the Federal awarding agency or pass-through entity may still review the specifications, with such review usually limited to the technical aspects of the proposed purchase.
- (b) The non-Federal entity must make available upon request, for the Federal awarding agency or pass-through entity pre-procurement review, procurement documents, such as requests for proposals or invitations for bids, or independent cost estimates, when:
 - (1) The non-Federal entity's procurement procedures or operation fails to comply with the procurement standards in this part;
 - (2) The procurement is expected to exceed the Simplified Acquisition Threshold and is to be awarded without competition or only one bid or offer is received in response to a solicitation;
 - (3) The procurement, which is expected to exceed the Simplified Acquisition Threshold, specifies a "brand name" product;
 - (4) The proposed contract is more than the Simplified Acquisition Threshold and is to be awarded to other than the apparent low bidder under a sealed bid procurement; or
 - (5) A proposed contract modification changes the scope of a contract or increases the contract amount by more than the Simplified Acquisition Threshold.
- (c) The non-Federal entity is exempt from the pre-procurement review in paragraph (b) of this section if the Federal awarding agency or pass-through entity determines that its procurement systems comply with the standards of this part.
 - (1) The non-Federal entity may request that its procurement system be reviewed by the Federal awarding agency or pass-through entity to determine whether its system meets these standards in order for its system to be certified. Generally, these reviews must occur where there is continuous high-dollar funding, and third-party contracts are awarded on a regular basis;
 - (2) The non-Federal entity may self-certify its procurement system. Such self-certification must not limit the Federal awarding agency's right to survey the system. Under a self-certification procedure, the Federal awarding agency may rely on written assurances from the non-Federal entity that it is complying with these standards. The non-Federal entity must cite specific policies, procedures, regulations, or standards as being in compliance with these requirements and have its system available for review.

§200.326 Bonding requirements

For construction or facility improvement contracts or subcontracts exceeding the Simplified Acquisition Threshold, the Federal awarding agency or pass-through entity may accept the bonding policy and requirements of the non-Federal entity provided that the Federal awarding agency or pass-through entity has made a determination that the Federal interest is adequately protected. If such a determination has not been made, the minimum requirements must be as follows:

- (a) A bid guarantee from each bidder equivalent to five percent of the bid price. The "bid guarantee" must consist of a firm commitment such as a bid bond, certified check, or other negotiable instrument accompanying a bid as assurance that the bidder will, upon acceptance of the bid, execute such contractual documents as may be required within the time specified.

- (b) A performance bond on the part of the contractor for 100 percent of the contract price. A “performance bond” is one executed in connection with a contract to secure fulfillment of all the contractor's requirements under such contract.
- (c) A payment bond on the part of the contractor for 100 percent of the contract price. A “payment bond” is one executed in connection with a contract to assure payment as required by law of all persons supplying labor and material in the execution of the work provided for in the contract.

§200.327 Contract provisions

The non-Federal entity's contracts must contain the applicable provisions described in Appendix II to this part.

9.3 2 C.F.R. Part 200, Appendix II

Appendix II to Part 200 - Contract Provisions for Non-Federal Entity Contracts Under Federal Awards

In addition to other provisions required by the Federal agency or non-Federal entity, all contracts made by the non-Federal entity under the Federal award must contain provisions covering the following, as applicable.

- (a) Contracts for more than the simplified acquisition threshold, which is the inflation adjusted amount determined by the Civilian Agency Acquisition Council and the Defense Acquisition Regulations Council (Councils) as authorized by 41 U.S.C. 1908, must address administrative, contractual, or legal remedies in instances where contractors violate or breach contract terms, and provide for such sanctions and penalties as appropriate.
- (b) All contracts in excess of \$10,000 must address termination for cause and for convenience by the non-Federal entity including the manner by which it will be affected and the basis for settlement.
- (c) Equal Employment Opportunity. Except as otherwise provided under 41 CFR Part 60, all contracts that meet the definition of “federally assisted construction contract” in 41 CFR Part 60-1.3 must include the equal opportunity clause provided under 41 CFR 60-1.4(b), in accordance with Executive Order 11246, “Equal Employment Opportunity” (30 FR 12319, 12935, 3 CFR Part, 1964-1965 Comp., p. 339), as amended by Executive Order 11375, “Amending Executive Order 11246 Relating to Equal Employment Opportunity,” and implementing regulations at 41 CFR part 60, “Office of Federal Contract Compliance Programs, Equal Employment Opportunity, Department of Labor.”
- (d) Davis-Bacon Act, as amended (40 U.S.C. 3141-3148). When required by Federal program legislation, all prime construction contracts in excess of \$2,000 awarded by non-Federal entities must include a provision for compliance with the Davis-Bacon Act (40 U.S.C. 3141-3144, and 3146-3148) as supplemented by Department of Labor regulations (29 CFR Part 5, “Labor Standards Provisions Applicable to Contracts Covering Federally Financed and Assisted Construction”). In accordance with the statute, contractors must be required to pay wages to laborers and mechanics at a rate not less than the prevailing wages specified in a wage determination made by the Secretary of Labor. In addition, contractors must be required to pay wages not less than once a week. The non-Federal entity must place a copy of the current prevailing wage determination issued by the Department of Labor in each solicitation. The decision to award a contract or subcontract must be conditioned upon the acceptance of the wage determination. The non-Federal entity must report all suspected or reported violations to the Federal awarding agency. The contracts must also include a provision for compliance with the Copeland “Anti-Kickback” Act (40 U.S.C. 3145), as supplemented by Department of Labor regulations (29 CFR Part 3, “Contractors and Subcontractors on Public Building or Public Work Financed in Whole or in Part by Loans or Grants from the United States”). The Act provides that each contractor or subrecipient must be prohibited from inducing, by any means, any person employed in the construction, completion, or repair of public work, to give up any part of the compensation to which he or

- she is otherwise entitled. The non-Federal entity must report all suspected or reported violations to the Federal awarding agency.
- (e) Contract Work Hours and Safety Standards Act (40 U.S.C. 3701-3708). Where applicable, all contracts awarded by the non-Federal entity in excess of \$100,000 that involve the employment of mechanics or laborers must include a provision for compliance with 40 U.S.C. 3702 and 3704, as supplemented by Department of Labor regulations (29 CFR Part 5). Under 40 U.S.C. 3702 of the Act, each contractor must be required to compute the wages of every mechanic and laborer on the basis of a standard work week of 40 hours. Work in excess of the standard work week is permissible provided that the worker is compensated at a rate of not less than one and a half times the basic rate of pay for all hours worked in excess of 40 hours in the work week. The requirements of 40 U.S.C. 3704 are applicable to construction work and provide that no laborer or mechanic must be required to work in surroundings or under working conditions which are unsanitary, hazardous, or dangerous. These requirements do not apply to the purchases of supplies or materials or articles ordinarily available on the open market, or contracts for transportation or transmission of intelligence.
 - (f) Rights to Inventions Made Under a Contract or Agreement. If the Federal award meets the definition of "funding agreement" under 37 CFR § 401.2 (a) and the recipient or subrecipient wishes to enter into a contract with a small business firm or nonprofit organization regarding the substitution of parties, assignment or performance of experimental, developmental, or research work under that "funding agreement," the recipient or subrecipient must comply with the requirements of 37 CFR Part 401, "Rights to Inventions Made by Nonprofit Organizations and Small Business Firms Under Government Grants, Contracts and Cooperative Agreements," and any implementing regulations issued by the awarding agency.
 - (g) Clean Air Act (42 U.S.C. 7401-7671g.) and the Federal Water Pollution Control Act (33 U.S.C. 1251-1387), as amended - Contracts and subgrants of amounts in excess of \$150,000 must contain a provision that requires the non-Federal award to agree to comply with all applicable standards, orders or regulations issued pursuant to the Clean Air Act (42 U.S.C. 7401-7671g) and the Federal Water Pollution Control Act as amended (33 U.S.C. 1251-1387). Violations must be reported to the Federal awarding agency and the Regional Office of the Environmental Protection Agency (EPA).
 - (h) Debarment and Suspension (Executive Orders 12549 and 12689) - A contract award (see 2 CFR 180.220) must not be made to parties listed on the governmentwide exclusions in the System for Award Management (SAM), in accordance with the OMB guidelines at 2 CFR 180 that implement Executive Orders 12549 (3 CFR part 1986 Comp., p. 189) and 12689 (3 CFR part 1989 Comp., p. 235), "Debarment and Suspension." SAM Exclusions contains the names of parties debarred, suspended, or otherwise excluded by agencies, as well as parties declared ineligible under statutory or regulatory authority other than Executive Order 12549.
 - (i) Byrd Anti-Lobbying Amendment (31 U.S.C. 1352) - Contractors that apply or bid for an award exceeding \$100,000 must file the required certification. Each tier certifies to the tier above that it will not and has not used Federal appropriated funds to pay any person or organization for influencing or attempting to influence an officer or employee of any agency, a member of Congress, officer or employee of Congress, or an employee of a member of Congress in connection with obtaining any Federal contract, grant or any other award covered by 31 U.S.C. 1352. Each tier must also disclose any lobbying with non-Federal funds that takes place in connection with obtaining any Federal award. Such disclosures are forwarded from tier to tier up to the non-Federal award.
 - (j) See § 200.323*
 - (k) See § 200.216**
 - (l) See § 200.322***

***§ 200.323 Procurement of recovered materials**

A non-Federal entity that is a state agency or agency of a political subdivision of a state and its contractors must comply with section 6002 of the Solid Waste Disposal Act, as amended by the Resource Conservation and Recovery Act. The requirements of Section 6002 include procuring only items designated in guidelines of the Environmental Protection Agency (EPA) at 40 CFR part 247 that contain the highest percentage of recovered materials practicable, consistent with maintaining a satisfactory level of competition, where the purchase price of the item exceeds \$10,000 or the value of the quantity acquired during the preceding fiscal year exceeded \$10,000; procuring solid waste management services in a manner that maximizes energy and resource recovery; and establishing an affirmative procurement program for procurement of recovered materials identified in the EPA guidelines.

****§ 200.216 Prohibition on certain telecommunications and video surveillance services or equipment**

- (a) Recipients and sub recipients are prohibited from obligating or expending loan or grant funds to:
- (1) Procure or obtain;
 - (2) Extend or renew a contract to procure or obtain; or
 - (3) Enter into a contract (or extend or renew a contract) to procure or obtain equipment, services, or systems that uses covered telecommunications equipment or services as a substantial or essential component of any system, or as critical technology as part of any system. As described in Public Law 115-232, section 889, covered telecommunications equipment is telecommunications equipment produced by Huawei Technologies Company or ZTE Corporation (or any subsidiary or affiliate of such entities).
 - (i) For the purpose of public safety, security of government facilities, physical security surveillance of critical infrastructure, and other national security purposes, video surveillance and telecommunications equipment produced by Hytera Communications Corporation, Hangzhou Hikvision Digital Technology Company, or Dahua Technology Company (or any subsidiary or affiliate of such entities).
 - (ii) Telecommunications or video surveillance services provided by such entities or using such equipment.
 - (iii) Telecommunications or video surveillance equipment or services produced or provided by an entity that the Secretary of Defense, in consultation with the Director of the National Intelligence or the Director of the Federal Bureau of Investigation, reasonably believes to be an entity owned or controlled by, or otherwise connected to, the government of a covered foreign country.
- (b) In implementing the prohibition under Public Law 115-232, section 889, subsection (f), paragraph (1), heads of executive agencies administering loan, grant, or subsidy programs shall prioritize available funding and technical support to assist affected businesses, institutions and organizations as is reasonably necessary for those affected entities to transition from covered communications equipment and services, to procure replacement equipment and services, and to ensure that communications service to users and customers is sustained.
- (c) See Public Law 115-232, section 889 for additional information.
- (d) See also § 200.471.

*****§ 200.322 Domestic preferences for procurements**

- (a) As appropriate and to the extent consistent with law, the non-Federal entity should, to the greatest extent practicable under a Federal award, provide a preference for the purchase, acquisition, or use of goods, products, or materials produced in the United States (including but not limited to iron, aluminum, steel, cement, and other manufactured products). The requirements of this section must be included in all subawards including all contracts and purchase orders for work or products under this award.

- (b) For purposes of this section:
 - (1) "Produced in the United States" means, for iron and steel products, that all manufacturing processes, from the initial melting stage through the application of coatings, occurred in the United States.
 - (2) "Manufactured products" means items and construction materials composed in whole or in part of non-ferrous metals such as aluminum; plastics and polymer-based products such as polyvinyl chloride pipe; aggregates such as concrete; glass, including optical fiber; and lumber.

9.4 Additional Contract Requirements Remedies

- (a) Standard: Contracts for more than the simplified acquisition threshold (\$150,000) must address administrative, contractual, or legal remedies in instances where contractors violate or breach contract terms and provide for such sanctions and penalties as appropriate. See 2 C.F.R. Part 200, Appendix II, A.
- (b) Applicability: This requirement applies to all FEMA grant and cooperative agreement programs.

Termination for Cause and Convenience

- (a) All contracts in excess of \$10,000 must address termination for cause and for convenience by the non-Federal entity including the manner by which it will be affected and the basis for settlement. See 2 C.F.R. Part 200, Appendix II, B.
- (b) Applicability. This requirement applies to all FEMA grant and cooperative agreement programs.

Equal Employment Opportunity

- (a) Standard. Except as otherwise provided under 41 C.F.R. Part 60, all contracts that meet the definition of "federally assisted construction contract" in 41 C.F.R. § 60-1.3 must include the equal opportunity clause provided under 41 C.F.R. § 60-1.4(b), in accordance with Executive Order 11246, Equal Employment Opportunity (30 Fed. Reg. 12319, 12935, 3 C.F.R. Part, 1964-1965 Comp., p. 339), as amended by Executive Order 11375, Amending Executive Order 11246 Relating to Equal Employment Opportunity, and implementing regulations at 41 C.F.R. Part 60 (Office of Federal Contract Compliance Programs, Equal Employment Opportunity, Department of Labor). See 2 C.F.R. Part 200, Appendix II, C.
- (b) Key Definitions.
 - (1) Federally Assisted Construction Contract. The regulation at 41 C.F.R. § 60-1.3 defines a "federally assisted construction contract" as any agreement or modification thereof between any applicant and a person for construction work which is paid for in whole or in part with funds obtained from the Government or borrowed on the credit of the Government pursuant to any Federal program involving a grant, contract, loan, insurance, or guarantee, or undertaken pursuant to any Federal program involving such grant, contract, loan, insurance, or guarantee, or any application or modification thereof approved by the Government for a grant, contract, loan, insurance, or guarantee under which the applicant itself participates in the construction work.
 - (2) Construction Work. The regulation at 41 C.F.R. § 60-1.3 defines "construction work" as the construction, rehabilitation, alteration, conversion, extension, demolition or repair of buildings, highways, or other changes or improvements to real property, including facilities providing utility services. The term also includes the supervision, inspection, and other onsite functions incidental to the actual construction.
- (c) Applicability. This requirement applies to all FEMA grant and cooperative agreement programs.
- (d) The regulation at 41 C.F.R. Part 60-1.4(b) requires the insertion of the following contract clause: "During the performance of this contract, the contractor agrees as follows:

- (1) The contractor will not discriminate against any employee or applicant for employment because of race, color, religion, sex, or national origin. The contractor will take affirmative action to ensure that applicants are employed, and that employees are treated during employment without regard to their race, color, religion, sex, or national origin. Such action shall include, but not be limited to the following: Employment, upgrading, demotion, or transfer; recruitment or recruitment advertising; layoff or termination; rates of pay or other forms of compensation; and selection for training, including apprenticeship. The contractor agrees to post in conspicuous places, available to employees and applicants for employment, notices to be provided setting forth the provisions of this nondiscrimination clause.
- (2) The contractor will, in all solicitations or advertisements for employees placed by or on behalf of the contractor, state that all qualified applicants will receive considerations for employment without regard to race, color, religion, sex, or national origin.
- (3) The contractor will send to each labor union or representative of workers with which he has a collective bargaining agreement or other contract or understanding, a notice to be provided advising the said labor union or workers' representatives of the contractor's commitments under this section and shall post copies of the notice in conspicuous places available to employees and applicants for employment.
- (4) The contractor will comply with all provisions of Executive Order 11246 of September 24, 1965, and of the rules, regulations, and relevant orders of the Secretary of Labor.
- (5) The contractor will furnish all information and reports required by Executive Order 11246 of September 24, 1965, and by rules, regulations, and orders of the Secretary of Labor, or pursuant thereto, and will permit access to his books, records, and accounts by the administering agency and the Secretary of Labor for purposes of investigation to ascertain compliance with such rules, regulations, and orders.
- (6) In the event of the contractor's noncompliance with the nondiscrimination clauses of this contract or with any of the said rules, regulations, or orders, this contract may be canceled, terminated, or suspended in whole or in part and the contractor may be declared ineligible for further Government contracts or federally assisted construction contracts in accordance with procedures authorized in Executive Order 11246 of September 24, 1965, and such other sanctions as may be imposed and remedies invoked as provided in Executive Order 11246 of September 24, 1965, or by rule, regulation, or order of the Secretary of Labor, or as otherwise provided by law.
- (7) The contractor will include the portion of the sentence immediately preceding paragraph (1) and the provisions of paragraphs (1) through (7) in every subcontract or purchase order unless exempted by rules, regulations, or orders of the Secretary of Labor issued pursuant to section 204 of Executive Order 11246 of September 24, 1965, so that such provisions will be binding upon each subcontractor or vendor. The contractor will take such action with respect to any subcontract or purchase order as the administering agency may direct as a means of enforcing such provisions, including sanctions for noncompliance: Provided, however, that in the event a contractor becomes involved in, or is threatened with, litigation with a subcontractor or vendor as a result of such direction by the administering agency the contractor may request the United States to enter into such litigation to protect the interests of the United States."

Davis Bacon Act and Copeland Anti-Kickback Act

- (a) Applicability of Davis-Bacon Act. The Davis-Bacon Act only applies to the emergency Management Preparedness Grant Program, Homeland Security Grant Program, Nonprofit Security Grant Program, Tribal Homeland Security Grant Program, Port Security Grant

- Program, and Transit Security Grant Program. It does not apply to other FEMA grant and cooperative agreement programs, including the Public Assistance Program.
- (b) All prime construction contracts in excess of \$2,000 awarded by non-Federal entities must include a provision for compliance with the Davis-Bacon Act (40 U.S.C. §§ 3141-3144 and 3146-3148) as supplemented by Department of Labor regulations at 29 C.F.R. Part 5 (Labor Standards Provisions Applicable to Contracts Covering Federally Financed and Assisted Construction)). See 2 C.F.R. Part 200, Appendix II, D.
 - (c) In accordance with the statute, contractors must be required to pay wages to laborers and mechanics at a rate not less than the prevailing wages specified in a wage determination made by the Secretary of Labor. In addition, contractors' must be required to pay wages not less than once a week.
 - (d) The non-Federal entity must place a copy of the current prevailing wage determination issued by the Department of Labor in each solicitation. The decision to award a contract or subcontract must be conditioned upon the acceptance of the wage determination. The non-Federal entity must report all suspected or reported violations to the Federal awarding agency.
 - (e) In contracts subject to the Davis-Bacon Act, the contracts must also include a provision for compliance with the Copeland "Anti-Kickback" Act (40 U.S.C. §3145), as supplemented by Department of Labor regulations at 29 C.F.R. Part 3 (Contractors and Subcontractors on Public Building or Public Work Financed in Whole or in Part by Loans or Grants from the United States). The Copeland Anti-Kickback Act provides that each contractor or subrecipient must be prohibited from inducing, by any means, any person employed in the construction, completion, or repair of public work, to give up any part of the compensation to which he or she is otherwise entitled. The non-Federal entity must report all suspected or reported violations to FEMA.
 - (f) The regulation at 29 C.F.R. § 5.5(a) does provide the required contract clause that applies to compliance with both the Davis-Bacon and Copeland Acts. However, as discussed in the previous subsection, the Davis-Bacon Act does not apply to Public Assistance recipients and subrecipients. In situations where the Davis-Bacon Act does not apply, neither does the Copeland "Anti-Kickback Act." However, for purposes of grant programs where both clauses do apply, FEMA requires the following contract clause:

"Compliance with the Copeland "Anti-Kickback" Act

- (1) Contractor. The contractor shall comply with 18 U.S.C. § 874, 40 U.S.C. § 3145, and the requirements of 29 C.F.R. pt. 3 as may be applicable, which are incorporated by reference into this contract.
- (2) Subcontracts. The contractor or subcontractor shall insert in any subcontracts the clause above and such other clauses as the FEMA may by appropriate instructions require, and also a clause requiring the subcontractors to include these clauses in any lower tier subcontracts. The prime contractor shall be responsible for the compliance by any subcontractor or lower tier subcontractor with all of these contract clauses.
- (3) Breach. A breach of the contract clauses above may be grounds for termination of the contract, and for debarment as a contractor and subcontractor as provided in 29 C.F.R. § 5.12."

Contract Work Hours and Safety Standards Act

- (a) Applicability: This requirement applies to all FEMA grant and cooperative agreement programs.
- (b) Where applicable (see 40 U.S.C. § 3701), all contracts awarded by the non-Federal entity in excess of \$100,000 that involve the employment of mechanics or laborers must include a provision for compliance with 40 U.S.C. §§ 3702 and 3704, as supplemented by Department of Labor regulations at 29 C.F.R. Part 5. See 2 C.F.R. Part 200, Appendix II, E.
- (c) Under 40 U.S.C. § 3702, each contractor must be required to compute the wages of every mechanic and laborer on the basis of a standard work week of 40 hours. Work in excess of

the standard work week is permissible provided that the worker is compensated at a rate of not less than one and a half times the basic rate of pay for all hours worked in excess of 40 hours in the work week.

- (d) The requirements of 40 U.S.C. § 3704 are applicable to construction work and provide that no laborer or mechanic must be required to work in surroundings or under working conditions which are unsanitary, hazardous, or dangerous. These requirements do not apply to the purchases of supplies or materials or articles ordinarily available on the open market, or contracts for transportation or transmission of intelligence.
- (e) The regulation at 29 C.F.R. § 5.5(b) provides the required contract clause concerning compliance with the Contract Work Hours and Safety Standards Act: "Compliance with the Contract Work Hours and Safety Standards Act"
 - (1) Overtime requirements. No contractor or subcontractor contracting for any part of the contract work which may require or involve the employment of laborers or mechanics shall require or permit any such laborer or mechanic in any workweek in which he or she is employed on such work to work in excess of forty hours in such workweek unless such laborer or mechanic receives compensation at a rate not less than one and one-half times the basic rate of pay for all hours worked in excess of forty hours in such workweek.
 - (2) Violation; liability for unpaid wages; liquidated damages. In the event of any violation of the clause set forth in paragraph (1) of this section the contractor and any subcontractor responsible therefor shall be liable for the unpaid wages. In addition, such contractor and subcontractor shall be liable to the United States (in the case of work done under contract for the District of Columbia or a territory, to such District or to such territory), for liquidated damages. Such liquidated damages shall be computed with respect to each individual laborer or mechanic, including watchmen and guards, employed in violation of the clause set forth in paragraph (1) of this section, in the sum of \$10 for each calendar day on which such individual was required or permitted to work in excess of the standard workweek of forty hours without payment of the overtime wages required by the clause set forth in paragraph (1) of this section.
 - (3) Withholding for unpaid wages and liquidated damages. The write in the name of the Federal agency or the loan or grant recipient) shall upon its own action or upon written request of an authorized representative of the Department of Labor withhold or cause to be withheld, from any moneys payable on account of work performed by the contractor or subcontractor under any such contract or any other Federal contract with the same prime contractor, or any other federally-assisted contract subject to the Contract Work Hours and Safety Standards Act, which is held by the same prime contractor, such sums as may be determined to be necessary to satisfy any liabilities of such contractor or subcontractor for unpaid wages and liquidated damages as provided in the clause set forth in paragraph (2) of this section.
 - (4) Subcontracts. The contractor or subcontractor shall insert in any subcontracts the clauses set forth in paragraph (1) through (4) of this section and also a clause requiring the subcontractors to include these clauses in any lower tier subcontracts. The prime contractor shall be responsible for compliance by any subcontractor or lower tier subcontractor with the clauses set forth in paragraphs (1) through (4) of this section."

Rights to Inventions Made Under a Contract or Agreement

- (a) Stafford Act Disaster Grants. This requirement does not apply to the Public Assistance, Hazard Mitigation Grant Program, Fire Management Assistance Grant Program, Crisis Counseling Assistance and Training Grant Program, Disaster Case Management Grant Program, and Federal Assistance to Individuals and Households - Other Needs Assistance Grant Program, as FEMA awards under these programs do not meet the definition of "funding agreement."

- (b) If the FEMA award meets the definition of "funding agreement" under 37 C.F.R. §401.2(a) and the non-Federal entity wishes to enter into a contract with a small business firm or nonprofit organization regarding the substitution of parties, assignment or performance of experimental, developmental, or research work under that "funding agreement," the non-Federal entity must comply with the requirements of 37 C.F.R. Part 401 (Rights to Inventions Made by Nonprofit Organizations and Small Business Firms Under Government Grants, Contracts and Cooperative Agreements), and any implementing regulations issued by FEMA. See 2 C.F.R. Part 200, Appendix II, F.
- (c) The regulation at 37 C.F.R. §401.2(a) currently defines "funding agreement" as any contract, grant, or cooperative agreement entered into between any Federal agency, other than the Tennessee Valley Authority, and any contractor for the performance of experimental, developmental, or research work funded in whole or in part by the Federal government. This term also includes any assignment, substitution of parties, or subcontract of any type entered into for the performance of experimental, developmental, or research work under a funding agreement as defined in the first sentence of this paragraph.

Clean Air Act and the Federal Water Pollution Control Act

Contracts of amounts in excess of \$150,000 must contain a provision that requires the contractor to agree to comply with all applicable standards, orders, or regulations issued pursuant to the Clean Air Act (42 U.S.C. §§ 7401-7671q) and the Federal Water Pollution Control Act as amended (33 U.S.C. §§ 1251- 1387). Violations must be reported to FEMA and the Regional Office of the Environmental Protection Agency. See 2 C.F.R. Part 200, Appendix II, 11 G.

- (a) The following provides a sample contract clause concerning compliance for contracts of amounts in excess of \$150,000: "Clean Air Act"
 - (1) The contractor agrees to comply with all applicable standards, orders or regulations issued pursuant to the Clean Air Act, as amended, 42 U.S.C. § 7401 et seq.
 - (2) The contractor agrees to report each violation to the (name of the state agency or local or Indian tribal government) and understands and agrees that the (name of the state agency or local or Indian tribal government) will, in turn, report each violation as required to assure notification to the (name of recipient), Federal Emergency Management Agency, and the appropriate Environmental Protection Agency Regional Office.
 - (3) The contractor agrees to include these requirements in each subcontract exceeding \$150,000 financed in whole or in part with Federal assistance provided by FEMA.

"Federal Water Pollution Control Act"

- (1) The contractor agrees to comply with all applicable standards, orders or regulations issued pursuant to the Federal Water Pollution Control Act, as amended, 33 U.S.C. 1251 et seq.
- (2) The contractor agrees to report each violation to the (name of the state agency or local or Indian tribal government) and understands and agrees that the (name of the state agency or local or Indian tribal government) will, in turn, report each violation as required to assure notification to the (name of recipient), Federal Emergency Management Agency, and the appropriate Environmental Protection Agency Regional Office.
- (3) The contractor agrees to include these requirements in each subcontract exceeding \$150,000 financed in whole or in part with Federal assistance provided by FEMA."

Debarment and Suspension

- (a) Applicability: The federal debarment and suspension provisions apply to all federal granting agencies.
- (b) Non-federal entities and contractors are subject to the debarment and suspension regulations implementing Executive Order 12549, Debarment and Suspension (1986) and Executive Order 12689, Debarment and Suspension (1989) at 2 C.F.R. Part 180 and the

Department of Homeland Security's regulations at 2 C.F.R. Part 3000 (Non-procurement Debarment and Suspension).

- (c) These regulations restrict awards, sub-awards, and contracts with certain parties that are debarred, suspended, or otherwise excluded from or ineligible for participation in Federal assistance programs and activities. See 2 C.F.R. Part 200, Appendix II, if H; and Procurement Guidance for Recipients and Subrecipients Under 2 C.F.R. Part 200 (Uniform Rules): Supplement to the Public Assistance Procurement Disaster Assistance Team (POAT) Field Manual Chapter IV, 6.d, and Appendix C, 2 [hereinafter POAT Supplement]. A contract award must not be made to parties listed in the SAM Exclusions. SAM Exclusions is the list maintained by the General Services Administration that contains the names of parties debarred, suspended, or otherwise excluded by agencies, as well as parties declared ineligible under statutory or regulatory authority other than Executive Order 12549. SAM exclusions can be accessed at www.sam.gov. See 2 C.F.R. § 180.530; POAT Supplement, Chapter IV, 6.d and Appendix C,
- (d) In general, an "excluded" party cannot receive a Federal grant award or a contract within the meaning of a "covered transaction," to include subawards and subcontracts. This includes parties that receive Federal funding indirectly, such as contractors to recipients and subrecipients. The key to the exclusion is whether there is a "covered transaction," which is any non-procurement transaction (unless excepted) at either a "primary" or "secondary" tier. Although "covered transactions" do not include contracts awarded by the Federal Government for purposes of the non-procurement common rule and DHS's implementing regulations, it does include some contracts awarded by recipients and subrecipient.
- (e) Specifically, a covered transaction includes the following contracts for goods or services:
 - (1) The contract is awarded by a recipient or subrecipient in the amount of at least \$25,000.
 - (2) The contract requires the approval of FEMA, regardless of amount.
 - (3) The contract is for federally-required audit services.
 - (4) A subcontract is also a covered transaction if it is awarded by the contractor of a recipient or subrecipient and requires either the approval of FEMA or is in excess of \$25,000.
- (f) The following provides a debarment and suspension clause. It incorporates an optional method of assurances that contractors are not excluded or disqualified:

Suspension and Debarment

- (1) This contract is a covered transaction for purposes of 2 C.F.R. pt. 180 and 2 C.F.R. pt. 3000. As such the contractor is required to verify that none of the contractor, its principals (defined at 2 C.F.R. § 180.995), or its affiliates (defined at 2 C.F.R. § 180.905) are excluded (defined at 2 C.F.R. § 180.940) or disqualified (defined at 2 C.F.R. § 180.935).
- (2) The contractor must comply with 2 C.F.R. pt. 180, subpart C and 2 C.F.R. pt. 3000, subpart C and must include a requirement to comply with these regulations in any lower tier covered transaction it enters into.
- (3) This certification is a material representation of fact relied upon by (insert name of subrecipient). If it is later determined that the contractor did not comply with 2 C.F.R. pt. 180, subpart C and 2 C.F.R. pt. 3000, subpart C, in addition to remedies available to (name of state agency serving as recipient and name of subrecipient), the Federal Government may pursue available remedies, including but not limited to suspension and/or debarment.
- (4) The bidder or proposer agrees to comply with the requirements of 2 C.F.R. pt. 180, subpart C and 2 C.F.R. pt. 3000, subpart C while this offer is valid and throughout the period of any contract that may arise from this offer. The bidder or proposer further agrees to include a provision requiring such compliance in its lower tier covered transactions."

Byrd Anti-Lobbying Amendment

- (a) Applicability: This requirement applies to all FEMA grant and cooperative agreement programs.
- (b) Contractors that apply or bid for an award of \$100,000 or more must file the required certification.

See 2 C.F.R. Part 200, Appendix II, 11 I; 44 C.F.R. Part 18; POAT Supplement, Chapter IV, 6.c; Appendix C, 4.

- (c) Each tier certifies to the tier above that it will not and has not used Federal appropriated funds to pay any person or organization for influencing or attempting to influence an officer or employee of any agency, a member of Congress, officer or employee of Congress, or an employee of a member of Congress in connection with obtaining any Federal contract, grant or any other award covered by 31 U.S.C. §1352. Each tier must also disclose any lobbying with non-Federal funds that takes place in connection with obtaining any Federal award. Such disclosures are forwarded from tier to tier up to the non-Federal award. See PDAT Supplement, Chapter IV, 6.c and Appendix C, 4.
- (d) The following provides a Byrd Anti-Lobbying contract clause: "Byrd Anti-Lobbying Amendment, 31 U.S.C. § 1352 (as amended) Contractors who apply or bid for an award of \$100,000 or more shall file the required certification. Each tier certifies to the tier above that it will not and has not used Federal appropriated funds to pay any person or organization for influencing or attempting to influence an officer or employee of any agency, a member of Congress, officer or employee of Congress, or an employee of a member of Congress in connection with obtaining any Federal contract, grant, or any other award covered by 31U.S.C. §1352. Each tier shall also disclose any lobbying with non-Federal funds that takes place in connection with obtaining any Federal award. Such disclosures are forwarded from tier to tier up to the recipient."

Procurement of Recovered Materials

- (a) Applicability: This requirement applies to all FEMA grant and cooperative agreement programs.
- (b) A non-Federal entity that is a state agency or agency of a political subdivision of a state and its contractors must comply with Section 6002 of the Solid Waste Disposal Act, Pub. L. No. 89-272 (1965) (codified as amended by the Resource Conservation and Recovery Act at 42 U.S.C. § 6962). See 2 C.F.R. Part 200, Appendix II, J; 2 C.F.R. § 200.322; PDAT Supplement, Chapter V, 7.
- (c) The requirements of Section 6002 include procuring only items designated in guidelines of the EPA at 40 C.F.R. Part 247 that contain the highest percentage of recovered materials practicable, consistent with maintaining a satisfactory level of competition, where the purchase price of the item exceeds \$10,000 or the value of the quantity acquired by the preceding fiscal year exceeded \$10,000; procuring solid waste management services in a manner that maximizes energy and resource recovery; and establishing an affirmative procurement program for procurement of recovered materials identified in the EPA guidelines.
- (d) The following provides the clause that a state agency or agency of a political subdivision of a state and its contractors can include in contracts meeting the above contract thresholds:
 - (1) In the performance of this contract, the Contractor shall make maximum use of products containing recovered materials that are EPA designated items unless the product cannot be acquired:
 - (i) Competitively within a timeframe providing for compliance with the contract performance schedule;
 - (ii) Meeting contract performance requirements; or
 - (iii) At a reasonable price.

- (2) Information about this requirement, along with the list of EPA designated items, is available at EPA's Comprehensive Procurement Guidelines website, <https://www.epa.gov/smm/comprehensiveprocurement-guideline-cpg-program>."

9.5 Additional FEMA Requirements

- (a) The Uniform Rules authorize FEMA to require additional provisions for nonfederal entity contracts. FEMA, pursuant to this authority, requires or recommends the following:
- (b) Changes. To be eligible for FEMA assistance under the non-Federal entity's FEMA grant or cooperative agreement, the cost of the change, modification, change order, or constructive change must be allowable, allocable, within the scope of its grant or cooperative agreement, and reasonable for the completion of project scope. FEMA recommends, therefore, that a non-Federal entity include a changes clause in its contract that describes how, if at all, changes can be made by either party to alter the method, price, or schedule of the work without breaching the contract. The language of the clause may differ depending on the nature of the contract and the end-item procured.
- (c) Access to Records. All non-Federal entities must place into their contracts a provision that all contractors and their successors, transferees, assignees, and subcontractors acknowledge and agree to comply with applicable provisions governing Department and FEMA access to records, accounts, documents, information, facilities, and staff. See DHS Standard Terms and Conditions, v 3.0, XXVI (2013).
- (d) The following provides a contract clause regarding access to records:
"Access to Records. The following access to records requirements apply to this contract:
(1) The contractor agrees to provide (insert name of state agency or local or Indian tribal government), (insert name of recipient), the FEMA Administrator, the Comptroller General of the United States, or any of their authorized representatives access to any books, documents, papers, and records of the Contractor which are directly pertinent to this contract for the purposes of making audits, examinations, excerpts, and transcriptions.
(2) The Contractor agrees to permit any of the foregoing parties to reproduce by any means whatsoever or to copy excerpts and transcriptions as reasonably needed.
(3) The contractor agrees to provide the FEMA Administrator or his authorized representatives' access to construction or other work sites pertaining to the work being completed under the contract."

DHS Seal, Logo, and Flags

- (a) All non-Federal entities must place in their contracts a provision that a contractor shall not use the DHS seal(s), logos, crests, or reproductions of flags or likenesses of DHS agency officials without specific FEMA pre-approval. See DHS Standard Terms and Conditions, v 3.0, XXV (2013).
- (b) The following provides a contract clause regarding DHS Seal, Logo, and Flags: "The contractor shall not use the DHS seal(s), logos, crests, or reproductions of flags or likenesses of DHS agency officials without specific FEMA pre-approval".

Compliance with Federal Law, Regulations, and Executive Orders

- (a) All non-Federal entities must place into their contracts an acknowledgement that FEMA financial assistance will be used to fund the contract along with the requirement that the contractor will comply with all applicable federal law, regulations, executive orders, and FEMA policies, procedures, and directives.
- (b) The following provides a contract clause regarding Compliance with Federal Law, Regulations, and Executive Orders: "This is an acknowledgement that FEMA financial assistance will be used to fund the contract only. The contractor will comply will all applicable federal law, regulations, executive orders, FEMA policies, procedures, and directives."

No Obligation by Federal Government

- (a) The non-Federal entity must include a provision in its contract that states that the Federal Government is not a party to the contract and is not subject to any obligations or liabilities to the non-Federal entity, contractor, or any other party pertaining to any matter resulting from the contract.
- (b) The following provides a contract clause regarding no obligation by the Federal Government: "The Federal Government is not a party to this contract and is not subject to any obligations or liabilities to the non-Federal entity, contractor, or any other party pertaining to any matter resulting from the contract."

Program Fraud and False or Fraudulent Statements or Related Acts

- (a) The non-Federal entity must include a provision in its contract that the contractor acknowledges that 31 U.S.C. Chap. 38 (Administrative Remedies for False Claims and Statements) applies to its actions pertaining to the contract.
- (b) The following provides a contract clause regarding Fraud and False or Fraudulent or Related Acts: "The contractor acknowledges that 31 U.S.C. Chap. 38 (Administrative Remedies for False Claims and Statements) applies to the contractor's actions pertaining to this contract."

9.6 Appendix A, 44 C.F.R. Part 18- Certification Regarding Lobbying

Certification for Contracts, Grants, Loans, and Cooperative Agreements (To be submitted with each bid or offer exceeding \$100,000). The undersigned [Contractor] certifies, to the best of his or her knowledge, that:

- (1) No Federal appropriated funds have been paid or will be paid, by or on behalf of the undersigned, to any person for influencing or attempting to influence an officer or employee of an agency, a Member of Congress, an officer or employee of Congress, or an employee of a Member of Congress in connection with the awarding of any Federal contract, the making of any Federal grant, the making of any Federal loan, the entering into of any cooperative agreement, and the extension, continuation, renewal, amendment, or modification of any Federal contract, grant, loan, or cooperative agreement.
- (2) If any funds other than Federal appropriated funds have been paid or will be paid to any person for influencing or attempting to influence an officer or employee of any agency, a Member of Congress, an officer or employee of Congress, or an employee of a Member of Congress in connection with this Federal contract, grant, loan, or cooperative agreement, the undersigned shall complete and submit Standard Form LLL, "Disclosure Form to Report Lobbying," in accordance with its instructions.
- (3) The undersigned shall require that the language of this certification be included in the award documents for all subawards at all tiers (including subcontracts, subgrants, and contracts under grants, loans, and cooperative agreements) and that all subrecipients shall certify and disclose accordingly. This certification is a material representation of fact upon which reliance was placed when this transaction was made or entered into. Submission of this certification is a prerequisite for making or entering into this transaction imposed by 31, U.S.C. § 1352 (as amended by the Lobbying Disclosure Act of 1995). Any person who fails to file the required certification shall be subject to a civil penalty of not less than \$10,000 and not more than \$100,000 for each such failure. The Contractor certifies or affirms the truthfulness and accuracy of each statement of its certification and disclosure, if any. In addition, the Contractor understands and agrees that the provisions of 31 U.S.C. § 3801 et seq., apply to this certification and disclosure, if any.

Signature of Contractor's Authorized Official

Name and Title of Contractor's Authorized Official Date

9.7 Requirements on FEMA funded projects - 44 CFR 13.36 – Procurement

- (a) States. When procuring property and services under a grant, a State will follow the same policies and procedures it uses for procurements from its non-Federal funds. The State will ensure that every purchase order or other contract includes any clauses required by Federal statutes and executive orders and their implementing regulations. Other grantees and subgrantees will follow paragraphs (b) through (i) in this section.
- (b) Procurement standards.
 - (1) Grantees and subgrantees will use their own procurement procedures which reflect applicable State and local laws and regulations, provided that the procurements conform to applicable Federal law and the standards identified in this section.
 - (2) Grantees and subgrantees will maintain a contract administration system which ensures that contractors perform in accordance with the terms, conditions, and specifications of their contracts or purchase orders.
 - (3) Grantees and subgrantees will maintain a written code of standards of conduct governing the performance of their employees engaged in the award and administration of contracts. No employee, officer, or agent of the grantee or subgrantee shall participate in selection, or in the award or administration of a contract supported by Federal funds if a conflict of interest, real or apparent, would be involved. Such a conflict would arise when:
 - (i) The employee, officer, or agent,
 - (ii) Any member of his immediate family,
 - (iii) His or her partner, or
 - (iv) An organization which employs, or is about to employ, any of the above, has a financial or other interest in the firm selected for award. The grantee's or subgrantee's officers, employees or agents will neither solicit nor accept gratuities, favors or anything of monetary value from contractors, potential contractors, or parties to sub-agreements. Grantee and subgrantees may set minimum rules where the financial interest is not substantial, or the gift is an unsolicited item of nominal intrinsic value. To the extent permitted by State or local law or regulations, such standards or conduct will provide for penalties, sanctions, or other disciplinary actions for violations of such standards by the grantee's and subgrantee's officers, employees, or agents, or by contractors or their agents. The awarding agency may in regulation provide additional prohibitions relative to real, apparent, or potential conflicts of interest.
 - (4) Grantee and subgrantee procedures will provide for a review of proposed procurements to avoid purchase of unnecessary or duplicative items. Consideration should be given to consolidating or breaking out procurements to obtain a more economical purchase. Where appropriate, an analysis will be made of lease versus purchase alternatives, and any other appropriate analysis to determine the most economical approach.
 - (5) To foster greater economy and efficiency, grantees and subgrantees are encouraged to enter into State and local intergovernmental agreements for procurement or use of common goods and services.
 - (6) Grantees and subgrantees are encouraged to use Federal excess and surplus property in lieu of purchasing new equipment and property whenever such use is feasible and reduces project costs.
 - (7) Grantees and subgrantees are encouraged to use value engineering clauses in contracts for construction projects of sufficient size to offer reasonable opportunities for cost reductions. Value engineering is a systematic and creative analysis of each contract item or task to ensure that its essential function is provided at the overall lower cost.
 - (8) Grantees and subgrantees will make awards only to responsible contractors possessing the ability to perform successfully under the terms and conditions of a

proposed procurement Consideration will be given to such matters as contractor integrity, compliance with public policy, record of past performance, and financial and technical resources.

- (9) Grantees and subgrantees will maintain records sufficient to detail the significant history of a procurement. These records will include but are not necessarily limited to the following: rationale for the method of procurement, selection of contract type, contractor selection or rejection, and the basis for the contract price.
 - (10) Grantees and subgrantees will use time and material type contracts only:
 - (i) After a determination that no other contract is suitable, and
 - (ii) If the contract includes a ceiling price that the contractor exceeds at its own risk.
 - (11) Grantees and subgrantees alone will be responsible, in accordance with good administrative practice and sound business judgment, for the settlement of all contractual and administrative issues arising out of procurements. These issues include, but are not limited to source evaluation, protests, disputes, and claims. These standards do not relieve the grantee or subgrantee of any contractual responsibilities under its contracts. Federal agencies will not substitute their judgment for that of the grantee or subgrantee unless the matter is primarily a Federal concern. Violations of law will be referred to the local, State, or Federal authority having proper jurisdiction.
 - (12) Grantees and subgrantees will have protest procedures to handle and resolve disputes relating to their procurements and shall in all instances disclose information regarding the protest to the awarding agency. A protester must exhaust all administrative remedies with the grantee and subgrantee before pursuing a protest with the Federal agency. Reviews of protests by the Federal agency will be limited to:
 - (i) Violations of Federal law or regulations and the standards of this section (violations of State or local law will be under the jurisdiction of State or local authorities) and
 - (ii) Violations of the grantee's or subgrantee's protest procedures for failure to review a complaint or protest. Protests received by the Federal agency other than those specified above will be referred to the grantee or subgrantee.
- (c) Competition
- (13) All procurement transactions will be conducted in a manner providing full and open competition consistent with the standards of section 13.36. Some of the situations considered to be restrictive of competition include but are not limited to:
 - (i) Placing unreasonable requirements on firms in order for them to qualify to do business,
 - (ii) Requiring unnecessary experience and excessive bonding,
 - (iii) Noncompetitive pricing practices between firms or between affiliated companies,
 - (iv) Noncompetitive awards to consultants that are on retainer contracts,
 - (v) Organizational conflicts of interest,
 - (vi) Specifying only a "brand name" product instead of allowing "an equal" product to be offered and describing the performance of other relevant requirements of the procurement, and
 - (vii) Any arbitrary action in the procurement process.

Grantees and subgrantees will conduct procurements in a manner that prohibits the use of statutorily or administratively imposed in-State or local geographical preferences in the evaluation of bids or proposals, except in those cases where applicable Federal statutes expressly mandate or encourage geographic preference. Nothing in this section preempts State licensing laws. When contracting for architectural and engineering (A/EI) services, geographic location may be a selection criterion provided its application leaves an appropriate number of qualified firms, given the nature and size of the project, to compete for the contract.

- (14) Grantees will have written selection procedures for procurement transactions. These procedures will ensure that all solicitations:
 - (i) Incorporate a clear and accurate description of the technical requirements for the material, product, or service to be procured. Such description shall not, in competitive procurements, contain features which unduly restrict competition. The description may include a statement of the qualitative nature of the material, product, or service to be procured, and when necessary, shall set forth those minimum essential characteristics and standards to which it must conform if it is to satisfy its intended use. Detailed product specifications should be avoided if at all possible. When it is impractical or uneconomical to make a clear and accurate description of the technical requirements, a "brand name or equal" description may be used as a means to define the performance or other salient requirements of a procurement. The specific features of the named brand which must be met by offerors shall be clearly stated; and
 - (ii) Identify all requirements which the offerors must fulfill and all other factors to be used in evaluating bids or proposals.
- (15) Grantees and subgrantees will ensure that all prequalified lists of persons, firms, or products which are used in acquiring goods and services are current and include enough qualified sources to ensure maximum open and free competition. Also, grantees and subgrantees will not preclude potential bidders from qualifying during the solicitation period.
- (d) Methods of procurement to be followed
 - (1) Procurement by small purchase procedures. Small purchase procedures are those relatively simple and informal procurement methods for securing services, supplies, or other property that do not cost more than the simplified acquisition threshold fixed at 41 U.S.C. 403(11) (currently set at \$100,000). If small purchase procedures are used, price or rate quotations shall be obtained from an adequate number of qualified sources.
 - (2) Procurement by sealed bids (formal advertising). Bids are publicly solicited, and a firm-fixed-price contract (lump sum or unit price) is awarded to the responsible bidder whose bid, conforming with all the material terms and conditions of the invitation for bids, is the lowest in price. The sealed bid method is the preferred method for procuring construction if the conditions in § 13.36(d)(2) (i) apply.
 - (i) In order for sealed bidding to be feasible, the following conditions should be present:
 - (A) A complete, adequate, and realistic specification or purchase description is available;
 - (B) Two or more responsible bidders are willing and able to compete effectively and for the business; and
 - (C) The procurement lends itself to a firm fixed price contract and the selection of the successful bidder can be made principally on the basis of price.
 - (ii) If sealed bids are used, the following requirements apply:
 - (A) The invitation for bids will be publicly advertised and bids shall be solicited from an adequate number of known suppliers, providing them sufficient time prior to the date set for opening the bids;
 - (B) The invitation for bids, which will include any specifications and pertinent attachments, shall define the items or services in order for the bidder to properly respond;
 - (C) All bids will be publicly opened at the time and place prescribed in the invitation for bids;
 - (D) A firm fixed-price contract award will be made in writing to the lowest responsive and responsible bidder. Where specified in bidding documents, factors such as discounts, transportation cost, and life

cycle costs shall be considered in determining which bid is lowest. Payment discounts will only be used to determine the low bid when prior experience indicates that such discounts are usually taken advantage of; and

- (E) Any or all bids may be rejected if there is a sound documented reason.
- (3) Procurement by competitive proposals. The technique of competitive proposals is normally conducted with more than one source submitting an offer, and either a fixed-price or cost- reimbursement type contract is awarded. It is generally used when conditions are not appropriate for the use of sealed bids. If this method is used, the following requirements apply:
- (i) Requests for proposals will be publicized and identify all evaluation factors and their relative importance. Any response to publicized requests for proposals shall be honored to the maximum extent practical;
 - (ii) Proposals will be solicited from an adequate number of qualified sources;
 - (iii) Grantees and subgrantees will have a method for conducting technical evaluations of the proposals received and for selecting awardees;
 - (iv) Awards will be made to the responsible firm whose proposal is most advantageous to the program, with price and other factors considered; and
 - (v) Grantees and subgrantees may use competitive proposal procedures for qualifications-based procurement of architectural/engineering (A/E) professional services whereby competitors' qualifications are evaluated, and the most qualified competitor is selected, subject to negotiation of fair and reasonable compensation. The method, where price is not used as a selection factor, can only be used in procurement of A/E professional services. It cannot be used to purchase other types of services though A/E firms are a potential source to perform the proposed effort.
- (4) Procurement by noncompetitive proposals is procurement through solicitation of a proposal from only one source, or after solicitation of a number of sources, competition is determined inadequate.
- (i) Procurement by noncompetitive proposals may be used only when the award of a contract is infeasible under small purchase procedures, sealed bids, or competitive proposals and one of the following circumstances applies:
 - (A) The item is available only from a single source;
 - (B) The public exigency or emergency for the requirement will not permit a delay resulting from competitive solicitation;
 - (C) The awarding agency authorizes noncompetitive proposals; or
 - (D) After solicitation of a number of sources, competition is determined inadequate.
 - (ii) Cost analysis, i.e., verifying the proposed cost data, the projections of the data, and the evaluation of the specific elements of costs and profits, is required.
 - (iii) Grantees and subgrantees may be required to submit the proposed procurement to the awarding agency for pre-award review in accordance with paragraph (g) of this section.
- (e) Contracting with small and minority firms, women's business enterprise and labor surplus area firms.
- (1) The grantee and subgrantee will take all necessary affirmative steps to assure that minority firms, women's business enterprises, and labor surplus area firms are used when possible.
 - (2) Affirmative steps shall include:
 - (i) Placing qualified small and minority businesses and women's business enterprises on solicitation lists;

- (ii) Assuring that small and minority businesses, and women's business enterprises are solicited whenever they are potential sources;
 - (iii) Dividing total requirements, when economically feasible, into smaller tasks or quantities to permit maximum participation by small and minority business, and women's business enterprises;
 - (iv) Establishing delivery schedules, where the requirement permits, which encourages participation by small and minority business, and women's business enterprises;
 - (v) Using the services and assistance of the Small Business Administration, and the Minority Business Development Agency of the Department of Commerce; and
 - (vi) Requiring the prime contractor, if subcontracts are to be let, to take the affirmative steps listed in paragraphs (e)(2) (i) through (v) of this section.
- (f) Contract cost and price.
- (1) Grantees and subgrantees must perform a cost or price analysis in connection with every procurement action including contract modifications. The method and degree of analysis is dependent on the facts surrounding the particular procurement situation, but as a starting point, grantees must make independent estimates before receiving bids or proposals. A cost analysis must be performed when the offeror is required to submit the elements of his estimated cost, e.g., under professional, consulting, and architectural engineering services contracts. A cost analysis will be necessary when adequate price competition is lacking, and for sole source procurements, including contract modifications or change orders, unless price reasonableness can be established on the basis of a catalog or market price of a commercial product sold in substantial quantities to the general public or based on prices set by law or regulation. A price analysis will be used in all other instances to determine the reasonableness of the proposed contract price.
 - (2) Grantees and subgrantees will negotiate profit as a separate element of the price for each contract in which there is no price competition and, in all cases, where cost analysis is performed. To establish a fair and reasonable profit, consideration will be given to the complexity of the work to be performed, the risk borne by the contractor, the contractor's investment, the amount of subcontracting, the quality of its record of past performance, and industry profit rates in the surrounding geographical area for similar work.
 - (3) Costs or prices based on estimated costs for contracts under grants will be allowable only to the extent that costs incurred, or cost estimates included in negotiated prices are consistent with Federal cost principles (see § 13.22). Grantees may reference their own cost principles that comply with the applicable Federal cost principles.
 - (4) The cost plus a percentage of cost and percentage of construction cost methods of contracting shall not be used.
- (g) Awarding agency review.
- (1) Grantees and subgrantees must make available, upon request of the awarding agency, technical specifications on proposed procurements where the awarding agency believes such review is needed to ensure that the item and/or service specified is the one being proposed for purchase. This review generally will take place prior to the time the specification is incorporated into a solicitation document. However, if the grantee or subgrantee desires to have the review accomplished after a solicitation has been developed, the awarding agency may still review the specifications, with such review usually limited to the technical aspects of the proposed purchase.
 - (2) Grantees and subgrantees must on request make available for awarding agency pre-award review procurement documents, such as requests for proposals or invitations for bids, independent cost estimates, etc. when:

- (i) A grantee's or subgrantee's procurement procedures or operation fails to comply with the procurement standards in this section; or
 - (ii) The procurement is expected to exceed the simplified acquisition threshold and is to be awarded without competition or only one bid or offer is received in response to a solicitation; or
 - (iii) The procurement, which is expected to exceed the simplified acquisition threshold, specifies a "brand name" product; or
 - (iv) The proposed award is more than the simplified acquisition threshold and is to be awarded to other than the apparent low bidder under a sealed bid procurement; or
 - (v) A proposed contract modification changes the scope of a contract or increases the contract amount by more than the simplified acquisition threshold.
- (3) A grantee or subgrantee will be exempt from the pre-award review in paragraph (g)(2) of this section if the awarding agency determines that its procurement systems comply with the standards of this section.
- (i) A grantee or subgrantee may request that its procurement system be reviewed by the awarding agency to determine whether its system meets these standards in order for its system to be certified. Generally, these reviews shall occur where there is a continuous high-dollar funding, and third-party contracts are awarded on a regular basis.
 - (ii) A grantee or subgrantee may self-certify its procurement system. Such self-certification shall not limit the awarding agency's right to survey the system. Under a self-certification procedure, awarding agencies may wish to rely on written assurances from the grantee or subgrantee that it is complying with these standards. A grantee or subgrantee will cite specific procedures, regulations, standards, etc., as being in compliance with these requirements and have its system available for review.
- (h) Bonding requirements. For construction or facility improvement contracts or subcontracts exceeding the simplified acquisition threshold, the awarding agency may accept the bonding policy and requirements of the grantee or subgrantee provided the awarding agency has made a determination that the awarding agency's interest is adequately protected. If such a determination has not been made, the minimum requirements shall be as follows:
- (1) A bid guarantee from each bidder equivalent to five percent of the bid price. The "bid guarantee" shall consist of a firm commitment such as a bid bond, certified check, or other negotiable instrument accompanying a bid as assurance that the bidder will, upon acceptance of his bid, execute such contractual documents as may be required within the time specified.
 - (2) A performance bond on the part of the contractor for 100 percent of the contract price. A "performance bond" is one executed in connection with a contract to secure fulfillment of all the contractor's obligations under such contract.
 - (3) A payment bond on the part of the contractor for 100 percent of the contract price. A "payment bond" is one executed in connection with a contract to assure payment as required by law of all persons supplying labor and material in the execution of the work provided for in the contract.
- (i) Contract provisions. A grantee's and subgrantee's contracts must contain provisions in paragraph (i) of this section. Federal agencies are permitted to require changes, remedies, changed conditions, access and records retention, suspension of work, and other clauses approved by the Office of Federal Procurement Policy.
- (1) Administrative, contractual, or legal remedies in instances where contractors violate or breach contract terms and provide for such sanctions and penalties as may be appropriate. (Contracts more than the simplified acquisition threshold)

- (2) Termination for cause and for convenience by the grantee or subgrantee including the manner by which it will be affected and the basis for settlement. (All contracts in excess of \$10,000)
- (3) Compliance with Executive Order 11246 of September 24, 1965, entitled "Equal Employment Opportunity," as amended by Executive Order 11375 of October 13, 1967, and as supplemented in Department of Labor regulations (41 CFR Chapter 60). (All construction contracts awarded in excess of \$10,000 by grantees and their contractors or subgrantees)
- (4) Compliance with the Copeland "Anti-Kickback" Act (18 U.S.C. 874) as supplemented in Department of Labor regulations (29 CFR Part 3). (All contracts and subgrants for construction or repair)
- (5) Compliance with the Davis-Bacon Act (40 U.S.C. 276a to 276a-7) as supplemented by Department of Labor regulations (29 CFR Part 5). (Construction contracts in excess of \$2000 awarded by grantees and subgrantees when required by Federal grant program legislation)
- (6) Compliance with Sections 103 and 107 of the Contract Work Hours and Safety Standards Act (40U.S.C. 327-330) as supplemented by Department of Labor regulations (29 CFR Part 5). (Construction contracts awarded by grantees and subgrantees in excess of \$2000, and in excess of \$2500 for other contracts which involve the employment of mechanics or laborers)
- (7) Notice of awarding agency requirements and regulations pertaining to reporting.
- (8) Notice of awarding agency requirements and regulations pertaining to patent rights with respect to any discovery or invention which arises or is developed in the course of or under such contract
- (9) Awarding agency requirements and regulations pertaining to copyrights and rights in data.
- (10) Access by the grantee, the subgrantee, the Federal grantor agency, the Comptroller General of the United States, or any of their duly authorized representatives to any books, documents, papers, and records of the contractor which are directly pertinent to that specific contract for the purpose of making audit, examination, excerpts, and transcriptions.
- (11) Retention of all required records for three years after grantees or subgrantees make final payments and all other pending matters are closed.
- (12) Compliance with all applicable standards, orders, or requirements issued under section 306 of the Clean Air Act (42 U.S.C. 1857(h)), section 508 of the Clean Water Act (33 U.S.C. 1368), Executive Order 11738, and Environmental Protection Agency regulations (40 CFR part 15). (Contracts, subcontracts, and subgrants of amounts in excess of \$100,000)
- (13) Mandatory standards and policies relating to energy efficiency which are contained in the state energy conservation plan issued in compliance with the Energy Policy and Conservation Act (Pub. L. 94- 163, 89 Stat. 871). [53 FR 8078, 8087, Mar. 11, 1988, as amended at 60 FR 19639, 19645, Apr.19, 1995]

9.8 Procurement Standards on U.S. Department of Housing and Urban Development (HUD) 24 CFR 85.36 - Procurement Standards

- (a) States. When procuring property and services under a grant, a State will follow the same policies and procedures it uses for procurements from its non-Federal funds. The State will ensure that every purchase order or other contract includes any clauses required by Federal statutes and executive orders and their implementing regulations. Other grantees and sub grantees will follow paragraphs (b) through(i) in this section.
- (b) Procurement standards.
 - (1) Grantees and sub grantees will use their own procurement procedures which reflect applicable State and local laws and regulations, provided that the procurements conform to applicable Federal law and the standards identified in this section.

- (2) Grantees and sub grantees will maintain a contract administration system which ensures that contractors perform in accordance with the terms, conditions, and specifications of their contracts or purchase orders.
- (3) Grantees and sub grantees will maintain a written code of standards of conduct governing the performance of their employees engaged in the award and administration of contracts. No employee, officer or agent of the grantee or sub grantee shall participate in selection, or in the award or administration of a contract supported by Federal funds if a conflict of interest, real or apparent, would be involved. Such a conflict would arise when:
 - (i) The employee, officer, or agent,
 - (ii) Any member of his immediate family,
 - (iii) His or her partner, or
 - (iv) An organization which employs, or is about to employ, any of the above, has a financial or other interest in the firm selected for award. The grantee's or sub grantee's officers, employees or agents will neither solicit nor accept gratuities, favors or anything of monetary value from contractors, potential contractors, or parties to sub agreements. Grantee and sub grantees may set minimum rules where the financial interest is not substantial, or the gift is an unsolicited item of nominal intrinsic value. To the extent permitted by State or local law or regulations, such standards or conduct will provide for penalties, sanctions, or other disciplinary actions for violations of such standards by the grantee's and sub grantee's officers, employees, or agents, or by contractors or their agents. The awarding agency may in regulation provide additional prohibitions relative to real, apparent, or potential conflicts of interest.
- (4) Grantee and sub grantee procedures will provide for a review of proposed procurements to avoid purchase of unnecessary or duplicative items. Consideration should be given to consolidating or breaking out procurements to obtain a more economical purchase. Where appropriate, an analysis will be made of lease versus purchase alternatives, and any other appropriate analysis to determine the most economical approach.
- (5) To foster greater economy and efficiency, grantees and sub grantees are encouraged to enter into State and local intergovernmental agreements for procurement or use of common goods and services.
- (6) Grantees and sub grantees are encouraged to use Federal excess and surplus property in lieu of purchasing new equipment and property whenever such use is feasible and reduces project costs.
- (7) Grantees and sub grantees are encouraged to use value engineering clauses in contracts for construction projects of sufficient size to offer reasonable opportunities for cost reductions. Value engineering is a systematic and creative analysis of each contract item or task to ensure that its essential function is provided at the overall lower cost.
- (8) Grantees and sub grantees will make awards only to responsible contractors possessing the ability to perform successfully under the terms and conditions of a proposed procurement. Consideration will be given to such matters as contractor integrity, compliance with public policy, record of past performance, and financial and technical resources.
- (9) Grantees and sub grantees will maintain records sufficient to detail the significant history of a procurement. These records will include but are not necessarily limited to the following: rationale for the method of procurement, selection of contract type, contractor selection or rejection, and the basis for the contract price.
- (10) Grantees and sub grantees will use time and material type contracts only:
 - (i) After a determination that no other contract is suitable, and
 - (ii) If the contract includes a ceiling price that the contractor exceeds at its own risk.

- (11) Grantees and sub grantees alone will be responsible, in accordance with good administrative practice and sound business judgment, for the settlement of all contractual and administrative issues arising out of procurements. These issues include, but are not limited to source evaluation, protests, disputes, and claims. These standards do not relieve the grantee or sub grantee of any contractual responsibilities under its contracts. Federal agencies will not substitute their judgment for that of the grantee or sub grantee unless the matter is primarily a Federal concern. Violations of law will be referred to the local, State, or Federal authority having proper jurisdiction.
 - (12) Grantees and sub grantees will have protest procedures to handle and resolve disputes relating to their procurements and shall in all instances disclose information regarding the protest to the awarding agency. A protester must exhaust all administrative remedies with the grantee and sub grantee before pursuing a protest with the Federal agency. Reviews of protests by the Federal agency will be limited to:
 - (i) Violations of Federal law or regulations and the standards of this section (violations of State or local law will be under the jurisdiction of State or local authorities) and
 - (ii) Violations of the grantee's or sub grantee's protest procedures for failure to review a complaint or protest. Protests received by the Federal agency other than those specified above will be referred to the grantee or sub grantee.
- (c) Competition.
- (1) All procurement transactions will be conducted in a manner providing full and open competition consistent with the standards of 85.36. Some of the situations considered to be restrictive of competition include but are not limited to:
 - (i) Placing unreasonable requirements on firms in order for them to qualify to do business,
 - (ii) Requiring unnecessary experience and excessive bonding,
 - (iii) Noncompetitive pricing practices between firms or between affiliated companies,
 - (iv) Noncompetitive awards to consultants that are on retainer contracts,
 - (v) Organizational conflicts of interest,
 - (vi) Specifying only a brand name product instead of allowing an equal product to be offered and describing the performance of other relevant requirements of the procurement, and
 - (vii) Any arbitrary action in the procurement process.
 - (2) Grantees and sub grantees will conduct procurements in a manner that prohibits the use of statutory or administratively imposed in-State or local geographical preferences in the evaluation of bids or proposals, except in those cases where applicable Federal statutes expressly mandate or encourage geographic preference. Nothing in this section preempts State licensing laws. When contracting for architectural and engineering (A/E) services, geographic location may be a selection criterion provided its application leaves an appropriate number of qualified firms, given the nature and size of the project, to compete for the contract.
 - (3) Grantees will have written selection procedures for procurement transactions. These procedures will ensure that all solicitations:
 - (i) Incorporate a clear and accurate description of the technical requirements for the material, product, or service to be procured. Such description shall not, in competitive procurements, contain features which unduly restrict competition. The description may include a statement of the qualitative nature of the material, product, or service to be procured, and when necessary, shall set forth those minimum essential characteristics and standards to which it must conform if it is to satisfy its intended use. Detailed product specifications should be avoided if at all possible. When it is impractical or uneconomical to make a clear and accurate description of the

technical requirements, a brand name or equal description may be used as a means to define the performance or other salient requirements of a procurement. The specific features of the named brand which must be met by offerors shall be clearly stated; and

- (ii) Identify all requirements which the offerors must fulfill and all other factors to be used in evaluating bids or proposals.
- (4) Grantees and sub grantees will ensure that all pre-qualified lists of persons, firms, or products which are used in acquiring goods and services are current and include enough qualified sources to ensure maximum open and free competition. Also, grantees and sub grantees will not preclude potential bidders from qualifying during the solicitation period.
- (d) Methods of procurement to be followed:
- (1) Procurement by small purchase procedures. Small purchase procedures are those relatively simple and informal procurement methods for securing services, supplies, or other property that do not cost more than the simplified acquisition threshold fixed at 41 U.S.C. 403(11) (currently set at \$100,000). If small purchase procurements are used, price or rate quotations will be obtained from an adequate number of qualified sources.
 - (2) Procurement by sealed bids (formal advertising). Bids are publicly solicited and a firm-fixed-price contract (lump sum or unit price) is awarded to the responsible bidder whose bid, conforming with all the material terms and conditions of the invitation for bids, is the lowest in price. The sealed bid method is the preferred method for procuring construction if the conditions in 85.36(d)(2)(i) apply.
 - (i) In order for sealed bidding to be feasible, the following conditions should be present:
 - (A) A complete, adequate, and realistic specification or purchase description is available;
 - (B) Two or more responsible bidders are willing and able to compete effectively for the business; and (C) The procurement lends itself to a firm fixed price contract and the selection of the successful bidder can be made principally on the basis of price.
 - (ii) If sealed bids are used, the following requirements apply:
 - (A) The invitation for bids will be publicly advertised and bids shall be solicited from an adequate number of known suppliers, providing them sufficient time prior to the date set for opening the bids;
 - (B) The invitation for bids, which will include any specifications and pertinent attachments, shall define the items or services in order for the bidder to properly respond;
 - (C) All bids will be publicly opened at the time and place prescribed in the invitation for bids;
 - (D) A firm fixed-price contract award will be made in writing to the lowest responsive and responsible bidder. Where specified in bidding documents, factors such as discounts, transportation cost, and life cycle costs shall be considered in determining which bid is lowest. Payment discounts will only be used to determine the low bid when prior experience indicates that such discounts are usually taken advantage of; and
 - (E) Any or all bids may be rejected if there is a sound documented reason.
 - (3) Procurement by competitive proposals. The technique of competitive proposals is normally conducted with more than one source submitting an offer, and either a fixed-price or cost reimbursement type contract is awarded. It is generally used when conditions are not appropriate for the use of sealed bids. If this method is used, the following requirements apply:

- (i) Requests for proposals will be publicized and identify all evaluation factors and their relative importance. Any response to publicized requests for proposals shall be honored to the maximum extent practical;
 - (ii) Proposals will be solicited from an adequate number of qualified sources;
 - (iii) Grantees and sub grantees will have a method for conducting technical evaluations of the proposals received and for selecting awardees;
 - (iv) Awards will be made to the responsible firm whose proposal is most advantageous to the program, with price and other factors considered; and
 - (v) Grantees and sub grantees may use competitive proposal procedures for qualifications-based procurement of architectural/engineering (A/E) professional services whereby competitors' qualifications are evaluated and the most qualified competitor is selected, subject to negotiation of fair and reasonable compensation. The method, where price is not used as a selection factor, can only be used in procurement of A/E professional services. It cannot be used to purchase other types of services though A/E firms are a potential source to perform the proposed effort.
- (4) Procurement by noncompetitive proposals is procurement through solicitation of a proposal from only one source, or after solicitation of a number of sources, competition is determined inadequate.
- (i) Procurement by noncompetitive proposals may be used only when the award of a contract is infeasible under small purchase procedures, sealed bids, or competitive proposals and one of the following circumstances applies:
 - (A) The item is available only from a single source;
 - (B) The public exigency or emergency for the requirement will not permit a delay resulting from competitive solicitation.
 - (C) The awarding agency authorizes noncompetitive proposals; or
 - (D) After solicitation of a number of sources, competition is determined inadequate.
 - (ii) Cost analysis, i.e., verifying the proposed cost data, the projections of the data, and the evaluation of the specific elements of costs and profit, is required.
 - (iii) Grantees and sub grantees may be required to submit the proposed procurement to the awarding agency for pre-award review in accordance with paragraph (g) of this section.
- (e) Contracting with small and minority firms, women's business enterprise and labor surplus area firms.
- (1) The grantee and sub grantee will take all necessary affirmative steps to assure that minority firms, women's business enterprises, and labor surplus area firms are used when possible.
 - (2) Affirmative steps shall include:
 - (i) Placing qualified small and minority businesses and women's business enterprises on solicitation lists;
 - (ii) Assuring that small and minority businesses, and women's business enterprises are solicited whenever they are potential sources;
 - (iii) Dividing total requirements, when economically feasible, into smaller tasks or quantities to permit maximum participation by small and minority business, and women's business enterprises;
 - (iv) Establishing delivery schedules, where the requirement permits, which encourage participation by small and minority business, and women's business enterprises;
 - (v) Using the services and assistance of the Small Business Administration, and the Minority Business Development Agency of the Department of Commerce; and

- (vi) Requiring the prime contractor, if subcontracts are to be let, to take the affirmative steps listed in paragraphs (e)(2) (i) through (v) of this section.
- (f) **Contract Cost and Price**
- (1) Grantee and sub grantees must perform a cost or price analysis in connection with every procurement action including contract modifications. The method and degree of analysis is dependent on the facts surrounding the particular procurement situation, but as a starting point, grantees must make independent estimates before receiving bids or proposals. A cost analysis must be performed when the offeror is required to submit the elements of his estimated cost, e.g., under professional consulting, and architectural engineering services contracts. A cost analysis will be necessary when adequate price competition is lacking, and the sole source procurements, including contract modifications or change orders, unless price reasonableness can be established on the basis of a catalog or market price on a commercial product sold in substantial quantities to the general public or based on prices set by law or regulation. A price analysis will be used in all other instances to determine the reasonableness of the proposed contract price.
 - (2) Grantees and subgrantees will negotiate profit as a separate element of the price for each contract in which there is no price competition and, in all cases, where cost analysis is performed. To establish a fair and reasonable profit, consideration will be given to the complexity of the work to be performed, the risk borne by the contractor, the contractor's investment, the amount of subcontracting, the quality of its record of past performance, and industry profit rates in the surrounding geographical area for similar work.
 - (3) Costs or prices based on estimated costs for contracts under grants will be allowable only to the extent that costs incurred or cost estimates included in negotiated prices are consistent with Federal cost principles (24 C.F.R. 85.22). Grantees may reference their own cost principles that comply with the applicable Federal cost principles.
 - (4) The cost plus a percentage of cost and percentage of contracting shall not be used.
- (g) **Awarding agency review.**
- (1) Grantees and sub grantees must make available, upon request of the awarding agency, technical specifications on proposed procurements where the awarding agency believes such review is needed to ensure that the item and/or service specified is the one being proposed for purchase. This review generally will take place prior to the time the specification is incorporated into a solicitation document. However, if the grantee or sub grantee desires to have the review accomplished after a solicitation has been developed, the awarding agency may still review the specifications, with such review usually limited to the technical aspects of the proposed purchase.
 - (2) Grantees and sub grantees must on request make available for awarding agency pre-award review procurement documents, such as requests for proposals or invitations for bids, independent cost estimates, etc., when:
 - (i) A grantee's or sub grantee's procurement procedures or operation fails to comply with the procurement standards in this section; or
 - (ii) The procurement is expected to exceed the simplified acquisition threshold and is to be awarded without competition or only one bid or offer is received in response to a solicitation; or
 - (iii) The procurement, which is expected to exceed the simplified acquisition threshold, specifies a brand name product; or
 - (iv) The proposed award is more than the simplified acquisition threshold and is to be awarded to other than the apparent low bidder under a sealed bid procurement; or
 - (v) A proposed contract modification changes the scope of a contract or increases the contract amount by more than the simplified acquisition threshold.

- (3) A grantee or sub grantee will be exempt from the pre-award review in paragraph (g)(2) of this section if the awarding agency determines that its procurement systems comply with the standards of this section.
 - (i) A grantee or sub grantee may request that its procurement system be reviewed by the awarding agency to determine whether its system meets these standards in order for its system to be certified. Generally, these reviews shall occur where there is a continuous high-dollar funding, and third-party contracts are awarded on a regular basis.
 - (ii) A grantee or sub grantee may self-certify its procurement system. Such self-certification shall not limit the awarding agency's right to survey the system. Under a self-certification procedure, awarding agencies may wish to rely on written assurances from the grantee or sub grantee that it is complying with these standards. A grantee or sub grantee will cite specific procedures, regulations, standards, etc., as being in compliance with these requirements and have its system available for review.
- (h) Bonding requirements.

For construction or facility improvement contracts or subcontracts exceeding the simplified acquisition threshold, the awarding agency may accept the bonding policy and requirements of the grantee or sub grantee provided the awarding agency has made a determination that the awarding agency's interest is adequately protected. If such a determination has not been made, the minimum requirements shall be as follows:

 - (1) A bid guarantee from each bidder equivalent to five percent of the bid price. The bid guarantee shall consist of a firm commitment such as a bid bond, certified check, or other negotiable instrument accompanying a bid as assurance that the bidder will, upon acceptance of his bid, execute such contractual documents as may be required within the time specified.
 - (2) A performance bond on the part of the contractor for 100 percent of the contract price. A performance bond is one executed in connection with a contract to secure fulfillment of all the contractor's obligations under such contract.
 - (3) A payment bond on the part of the contractor for 100 percent of the contract price. A payment bond is one executed in connection with a contract to assure payment as required by law of all persons supplying labor and material in the execution of the work provided for in the contract.
- (i) Contract provisions.

A grantee's and sub grantee's contracts must contain provisions in paragraph (i) of this section. Federal agencies are permitted to require changes, remedies, changed conditions, access and records retention, suspension of work, and other clauses approved by the Office of Procurement Policy.

 - (1) Administrative, contractual, or legal remedies in instances where contractors violate or breach contract terms and provide for such sanctions and penalties as may be appropriate. (Contracts more than the simplified acquisition threshold)
 - (2) Termination for cause and for convenience by the grantee or sub grantee including the manner by which it will be affected and the basis for settlement. (All contracts in excess of \$10,000)
 - (3) Compliance with Executive Order 11246 of September 24, 1965 entitled "Equal Employment Opportunity," as amended by Executive Order 11375 of October 13, 1967, and as supplemented in Department of Labor regulations (41 CFR Chapter 60). (All construction contracts awarded in excess of \$10,000 by grantees and their contractors or sub grantees)
 - (4) Compliance with the Copeland "Anti-Kickback" Act (18 USC 874) as supplemented in Department of Labor regulations (29 CFR part 3). (All contracts and subgrants for construction or repair).
 - (5) Compliance with the Davis-Bacon Act (40 U.S.C. 276a to a-7) as supplemented by Department of Labor regulations (29 CFR part SJ. (Construction contracts in excess

- of \$2,000 awarded by grantees and subgrantees when required by Federal grant program legislation)
- (6) Compliance with Sections 103 and 107 of the Contract Work Hours and Safety Standards Act (40 U.S.C. 327-330) as supplemented by Department of Labor regulations (29 CFR part 5). (Construction contracts awarded by grantees and subgrantees in excess of \$2,000, and in excess of \$2,500 for other contracts which involve the employment of mechanics or laborers)
 - (7) Notice of awarding agency requirements and regulations pertaining to reporting.
 - (8) Notice of awarding agency requirements and regulations pertaining to patent rights with respect to any discovery or invention which arises or is developed in the course of or under such contract.
 - (9) Awarding agency requirements and regulations pertaining to copyrights and rights in data.
 - (10) Access by the grantee, the subgrantee, the Federal grant agency, the Comptroller General of the United States, or any of their duly authorized representatives to any books, documents, papers, and records of the contractor which are directly pertinent to that specific contract for the purpose of making audit, examination, excerpts, and transcriptions.
 - (11) Retention of all required records for three years after grantees or subgrantees make final payments and all other pending matters are closed.
 - (12) Compliance with all applicable standards, orders, or requirements issued under section 306 of the Clean Air Act (42 U.S.C. 1857(h)), section 508 of the Clean Water Act (33 U.S.C. 1368), Executive Order 11738, and Environmental Protection Agency regulations (40 CFR part 15). (Contracts, subcontracts, and subgrants of amounts in excess of \$100,000).
 - (13) Mandatory standards and policies relating to energy efficiency which are contained in the state energy conservation plan issued in compliance with the Energy Policy and Conservation Act (Pub. L. 94- 163).

DAVIS-BACON PREVAILING WAGE RATES

"General Decision Number: TX20230214 01/06/2023

Superseded General Decision Number: TX20220214

State: Texas

Construction Type: Building

Counties: Leon and Milam Counties in Texas.

BUILDING CONSTRUCTION PROJECTS (does not include single family homes or apartments up to and including 4 stories).

Note: Contracts subject to the Davis-Bacon Act are generally required to pay at least the applicable minimum wage rate required under Executive Order 14026 or Executive Order 13658. Please note that these Executive Orders apply to covered contracts entered into by the federal government that are subject to the Davis-Bacon Act itself, but do not apply to contracts subject only to the Davis-Bacon Related Acts, including those set forth at 29 CFR 5.1(a)(2)-(60).

If the contract is entered into on or after January 30, 2022, or the contract is renewed or extended (e.g., an option is exercised) on or after January 30, 2022: Executive Order 14026 generally applies to the contract. The contractor must pay all covered workers at least \$16.20 per hour (or the applicable wage rate listed on this wage determination, if it is higher) for all hours spent performing on the contract in 2023.

If the contract was awarded on or between January 1, 2015 and January 29, 2022, and the contract is not renewed or extended on or after January 30, 2022: Executive Order 13658 generally applies to the contract. The contractor must pay all covered workers at least \$12.15 per hour (or the applicable wage rate listed on this wage determination, if it is higher) for all hours spent performing on that contract in 2023.

The applicable Executive Order minimum wage rate will be adjusted annually. If this contract is covered by one of the Executive Orders and a classification considered necessary for performance of work on the contract does not appear on this wage determination, the contractor must still submit a conformance request.

Additional information on contractor requirements and worker protections under the Executive Orders is available at <http://www.dol.gov/whd/govcontracts>.

Modification Number Publication Date
0 01/06/2023

ASBE0021-006 08/01/2017

LEON COUNTY

	Rates	Fringes
Heat and Frost Insulator/Asbestos Worker	\$ 25.87	7.23

ASBE0087-003 06/06/2022

MILAM COUNTY

	Rates	Fringes
ASBESTOS WORKER/HEAT & FROST INSULATOR	\$ 28.10	8.29
BOIL0074-003 01/01/2021		
BOILERMAKER	\$ 29.47	24.10
CARP0551-007 04/01/2021		
CARPENTER (Form Work Only)	\$ 25.86	9.08
IRON0263-009 06/01/2022		

LEON COUNTY

Ironworkers: Reinforcing & structural	\$ 27.14	7.68
IRON0482-009 06/01/2021		

MILAM COUNTY

IRONWORKER, STRUCTURAL AND REINFORCING	\$ 25.05	6.95
LABO0154-002 05/01/2008		

MILAM COUNTY

Laborers: (Mason Tender - Cement/Concrete)	\$ 12.98 **	3.49
LABO0154-018 05/01/2008		

LEON COUNTY

Laborers: (Mason Tender - Cement/Concrete)	\$ 14.53 **	3.49
PLUM0068-002 10/01/2022		
PLUMBER	\$ 37.83	11.71
SUTX2009-101 04/20/2009		
BRICKLAYER	\$ 18.00	0.00
CARPENTER, Includes Acoustical Ceiling Installation, Batt Insulation, and Metal Stud Installation (Excludes Drywall Hanging, and Form Work)	\$ 15.13 **	2.63

	Rates	Fringes
CEMENT MASON/CONCRETE FINISHER...	\$ 12.09 **	0.00
DRYWALL HANGER	\$ 13.89 **	1.00
ELECTRICIAN	\$ 18.06	4.87
LABORER: Common or General	\$ 9.24 **	0.00
LABORER: Landscape & Irrigation	\$ 8.50 **	0.22
LABORER: Mason Tender - Brick	\$ 12.02 **	0.00
LABORER: Mortar Mixer	\$ 12.00 **	0.00
OPERATOR: Backhoe/Excavator/Trackhoe	\$ 14.67 **	0.47
OPERATOR: Bulldozer	\$ 13.00 **	0.35
OPERATOR: Crane	\$ 21.33	0.00
OPERATOR: Forklift	\$ 14.58 **	0.00
OPERATOR: Loader (Front End)	\$ 10.54 **	0.00
PAINTER: Brush, Roller and Spray	\$ 11.75 **	0.00
ROOFER	\$ 13.64 **	1.80
SHEET METAL WORKER	\$ 17.00	0.00
TILE SETTER	\$ 15.00 **	0.00
TRUCK DRIVER	\$ 10.68 **	0.34

WELDERS - Receive rate prescribed for craft performing operation to which welding is incidental.

** Workers in this classification may be entitled to a higher minimum wage under Executive Order 14026 (\$16.20) or 13658 (\$12.15). Please see the Note at the top of the wage determination for more information.

Note: Executive Order (EO) 13706, Establishing Paid Sick Leave for Federal Contractors applies to all contracts subject to the Davis-Bacon Act for which the contract is awarded (and any solicitation was issued) on or after January 1, 2017. If this contract is covered by the EO, the contractor must provide employees with 1 hour of paid sick leave for every 30 hours they work, up to 56 hours of paid sick leave each year. Employees must be permitted to use paid sick leave for their own illness, injury, or other health-related needs, including preventive care; to assist a family member (or person who is like family to the employee) who is ill, injured, or has other health-related needs, including preventive care; or for reasons resulting from, or to assist a family member (or person who is like family to the employee) who is a victim of, domestic violence, sexual assault, or stalking. Additional information on contractor requirements and worker protections under the EO is available at <https://www.dol.gov/agencies/whd/government-contracts>. Unlisted classifications needed for work not included within the scope of the classifications listed may be added after award only as provided in the labor standards contract clauses (29CFR 5.5 (a) (1) (ii)).

The body of each wage determination lists the classification and wage rates that have been found to be prevailing for the cited type(s) of construction in the area covered by the wage determination. The classifications are listed in alphabetical order of ""identifiers"" that indicate whether the particular rate is a union rate (current union negotiated rate for local), a survey rate (weighted average rate) or a union average rate (weighted union average rate).

Union Rate Identifiers

A four letter classification abbreviation identifier enclosed in dotted lines beginning with characters other than ""SU"" or ""UAVG"" denotes that the union classification and rate were prevailing for that classification in the survey. Example: PLUM0198-005 07/01/2014. PLUM is an abbreviation identifier of the union which prevailed in the survey for this classification, which in this example would be Plumbers. 0198 indicates the local union number or district council number where applicable, i.e., Plumbers Local 0198. The next number, 005 in the example, is an internal number used in processing the wage determination. 07/01/2014 is the effective date of the most current negotiated rate, which in this example is July 1, 2014. Union prevailing wage rates are updated to reflect all rate changes in the collective bargaining agreement (CBA) governing this classification and rate.

Survey Rate Identifiers

Classifications listed under the ""SU"" identifier indicate that no one rate prevailed for this classification in the survey and the published rate is derived by computing a weighted average rate based on all the rates reported in the survey for that classification. As this weighted average rate includes all rates reported in the survey, it may include both union and non-union rates. Example: SULA2012-007 5/13/2014. SU indicates the rates are survey rates based on a weighted average calculation of rates and are not majority rates. LA indicates the State of Louisiana. 2012 is the year of survey on which these classifications and rates are based. The next number, 007 in the example, is an internal number used in producing the wage determination. 5/13/2014 indicates the survey completion date for the classifications and rates under that identifier. Survey wage rates are not updated and remain in effect until a new survey is conducted.

Union Average Rate Identifiers

Classification(s) listed under the UAVG identifier indicate that no single majority rate prevailed for those classifications; however, 100% of the data reported for the classifications was union data. EXAMPLE: UAVG-OH-0010 08/29/2014. UAVG indicates that the rate is a weighted union average rate. OH indicates the state. The next number, 0010 in the example, is an internal number used in producing the wage determination. 08/29/2014 indicates the survey completion date for the classifications and rates under that identifier. A UAVG rate will be updated once a year, usually in January of each year, to reflect a weighted average of the current negotiated/CBA rate of the union locals from which the rate is based.

WAGE DETERMINATION APPEALS PROCESS

1.) Has there been an initial decision in the matter? This can be:

- * an existing published wage determination
- * a survey underlying a wage determination
- * a Wage and Hour Division letter setting forth a position on a wage determination matter
- * a conformance (additional classification and rate) ruling

On survey related matters, initial contact, including requests for summaries of surveys, should be with the Wage and Hour National Office because National Office has responsibility for the Davis-Bacon survey program. If the response from this initial contact is not satisfactory, then the process

described in 2.) and 3.) should be followed. With regard to any other matter not yet ripe for the formal process described here, initial contact should be with the Branch of Construction Wage Determinations. Write to:

Branch of Construction Wage Determinations
Wage and Hour Division
U.S. Department of Labor
200 Constitution Avenue, N.W.
Washington, DC 20210

- 2.) If the answer to the question in 1.) is yes, then an interested party (those affected by the action) can request review and reconsideration from the Wage and Hour Administrator (See 29 CFR Part 1.8 and 29 CFR Part 7). Write to:

Wage and Hour Administrator
U.S. Department of Labor
200 Constitution Avenue, N.W.
Washington, DC 20210

The request should be accompanied by a full statement of the interested party's position and by any information (wage payment data, project description, area practice material, etc.) that the requestor considers relevant to the issue.

- 3.) If the decision of the Administrator is not favorable, an interested party may appeal directly to the Administrative Review Board (formerly the Wage Appeals Board). Write to:

Administrative Review Board
U.S. Department of Labor
200 Constitution Avenue, N.W.
Washington, DC 20210

- 4.) All decisions by the Administrative Review Board are final.

=====

END OF GENERAL DECISION"

VENDOR REFERENCES

Please list at least three (3) companies or governmental agencies (preferably a municipality) where the same or similar products and/or services as contained in this specification package were recently provided.

THIS FORM MUST BE RETURNED WITH YOUR BID.

REFERENCE ONE

Government/Company Name: _____

Address: _____

Contact Person and Title: _____

Phone: _____ Fax: _____

Contract Period: _____ Scope of Work: _____

REFERENCE TWO

Government/Company Name: _____

Address: _____

Contact Person and Title: _____

Phone: _____ Fax: _____

Contract Period: _____ Scope of Work: _____

REFERENCE THREE

Government/Company Name: _____

Address: _____

Contact Person and Title: _____

Phone: _____ Fax: _____

Contract Period: _____ Scope of Work: _____

CERTIFICATE OF INTERESTED PARTIES

FORM 1295

Complete Nos. 1 - 4 and 6 if there are interested parties. Complete Nos. 1, 2, 3, 5, and 6 if there are no interested parties.	OFFICE USE ONLY
1 Name of business entity filing form, and the city, state and country of the business entity's place of business.	Must file online at www.ethics.state.tx.us/File
2 Name of governmental entity or state agency that is a party to the contract for which the form is being filed.	

3 Provide the identification number used by the governmental entity or state agency to track or identify the contract, and provide a description of the services, goods, or other property to be provided under the contract.

4 Name of Interested Party	City, State, Country (place of business)	Nature of Interest (check applicable)	
		Controlling	Intermediary

5 Check only if there is NO Interested Party.

6 UNSWORN DECLARATION

My name is _____, and my date of birth is _____.

My address _____
(street) (city) (state) (zip code) (country)

I declare under penalty of perjury that the foregoing is true and correct.

Executed in _____ County, State of _____, on the _____ day of _____, 20____.
(month) (year)

 Signature of authorized agent of contracting business entity
 (Declarant)

ADD ADDITIONAL PAGES AS NECESSARY

PLEASE COMPLETE AND SIGN THIS CIQ FORM IF THERE IS A CONFLICT OF INTEREST BETWEEN THE BIDDER AND LEON COUNTY. IF THERE IS NO CONFLICT, PLEASE NOTATE THAT ON THE FORM AND RETURN WITH THE BID PROPOSAL.

CONFLICT OF INTEREST QUESTIONNAIRE		FORM CIQ
For vendor doing business with local governmental entity		
<p>This questionnaire reflects changes made to the law by H.B. 23, 84th Leg., Regular Session.</p> <p>This questionnaire is being filed in accordance with Chapter 176, Local Government Code, by a vendor who has a business relationship as defined by Section 176.001(1-a) with a local governmental entity and the vendor meets requirements under Section 176.006(a).</p> <p>By law this questionnaire must be filed with the records administrator of the local governmental entity not later than the 7th business day after the date the vendor becomes aware of facts that require the statement to be filed. See Section 176.006(a-1), Local Government Code.</p> <p>A vendor commits an offense if the vendor knowingly violates Section 176.006, Local Government Code. An offense under this section is a misdemeanor.</p>	OFFICE USE ONLY <hr/> Date Received	
1 Name of vendor who has a business relationship with local governmental entity.		
2 <input type="checkbox"/> Check this box if you are filing an update to a previously filed questionnaire. (The law requires that you file an updated completed questionnaire with the appropriate filing authority not later than the 7th business day after the date on which you became aware that the originally filed questionnaire was incomplete or inaccurate.)		
3 Name of local government officer about whom the information is being disclosed.	<hr style="width: 50%; margin: 0 auto;"/> Name of Officer	
4 Describe each employment or other business relationship with the local government officer, or a family member of the officer, as described by Section 176.003(a)(2)(A). Also describe any family relationship with the local government officer. Complete subparts A and B for each employment or business relationship described. Attach additional pages to this Form CIQ as necessary.		
<p style="margin-left: 40px;">A. Is the local government officer or a family member of the officer receiving or likely to receive taxable income, other than investment income, from the vendor?</p> <p style="margin-left: 100px;"> <input type="checkbox"/> Yes <input type="checkbox"/> No </p> <p style="margin-left: 40px;">B. Is the vendor receiving or likely to receive taxable income, other than investment income, from or at the direction of the local government officer or a family member of the officer AND the taxable income is not received from the local governmental entity?</p> <p style="margin-left: 100px;"> <input type="checkbox"/> Yes <input type="checkbox"/> No </p>		
5 Describe each employment or business relationship that the vendor named in Section 1 maintains with a corporation or other business entity with respect to which the local government officer serves as an officer or director, or holds an ownership interest of one percent or more.		
6 <input type="checkbox"/> Check this box if the vendor has given the local government officer or a family member of the officer one or more gifts as described in Section 176.003(a)(2)(B), excluding gifts described in Section 176.003(a-1).		
7		
<hr style="width: 80%; margin: 0;"/> Signature of vendor doing business with the governmental entity		<hr style="width: 80%; margin: 0;"/> Date

MINIMUM SPECIFICATIONS

Description of Project:

Leon County is accepting bids for the construction and installation of fencing at two communications tower sites, one located in Normangee, Texas and one in Oakwood, Texas.

Scope of Work:

CONTRACTOR shall construct and install fencing according to the following project requirements:

- **Corner and gate fence posts shall be bonded to the site grounding system using an exothermic welding process.**
- Fencing shall be 8-feet high, 9-gauge, 2-inch zinc-coated diamond mesh. Corners, line posts, and gate posts (2½-inch, 2-inch, and 4-inch respectively) shall also be hot-dipped galvanized. Top rail brace (1¼-inch) and truss rods (½-inch) also are required. Posts to be spaced 10 feet apart.
- The mesh fencing material shall be secured to terminal posts using stretcher bars and steel bands and line posts using wire clips.
- The top of the fencing shall have 3-strand barbed wire with 45-degree extension arms pointed outside the fence area. Gates at the tower bases shall include a lockable strong-arm industrial gate latch, a lockable commercial drop rod, and a malleable mushroom-style center stop. Gate stop latches, required for both gate halves, shall be installed to secure the gates in the open position for each location.
- Qty of 4 - 6-ft. W x 8-ft. H 9-gauge chain link gates (Two gates at each tower base) to construct a 12 ft. opening).
- Qty of 6 – 6-ft. W x 8-ft. H 9-gauge chain link gates (One at each guy anchor-Qty 3 per tower location).
- All guy wire anchors will be fenced with the same fencing materials as the tower compound. Each anchor point will have one lockable pedestrian gate. The fence will be designed to allow a 2-foot clearance, minimum, from the concrete foundations.
- All footings shall be set in concrete.

All bidders are encouraged to complete a pre-bid site visit in order to review the location, grade, and slope of the areas to be fenced. Arrangements for the site visits may be made by contacting Bob Hickman at 979-571-6565. The project sites are located as follows:

- 17664 FM 3 South, Normangee, TX 77871
- 27427 FM 542, Oakwood, TX 75855

A visual description for each location can be found on pages 60 through 61. Architectural schematics can be found on page 62 through 65 for the project fencing standards.

NORMANGEE TOWER

NOT TO SCALE

Illustration purposes only

- 228 FEET 8' FENCING AROUND TOWER STRUCTURES
- 102 FEET 8' FENCING AT EACH GUY ANCHOR - TOTAL 306 FEET
- QTY OF 5 GATES, 6' W X 8' H (2 AT TOWER, 1 AT EACH GUY ANCHOR)
- 3-STRAND BARBED WIRE ON ALL FENCING AND GATES

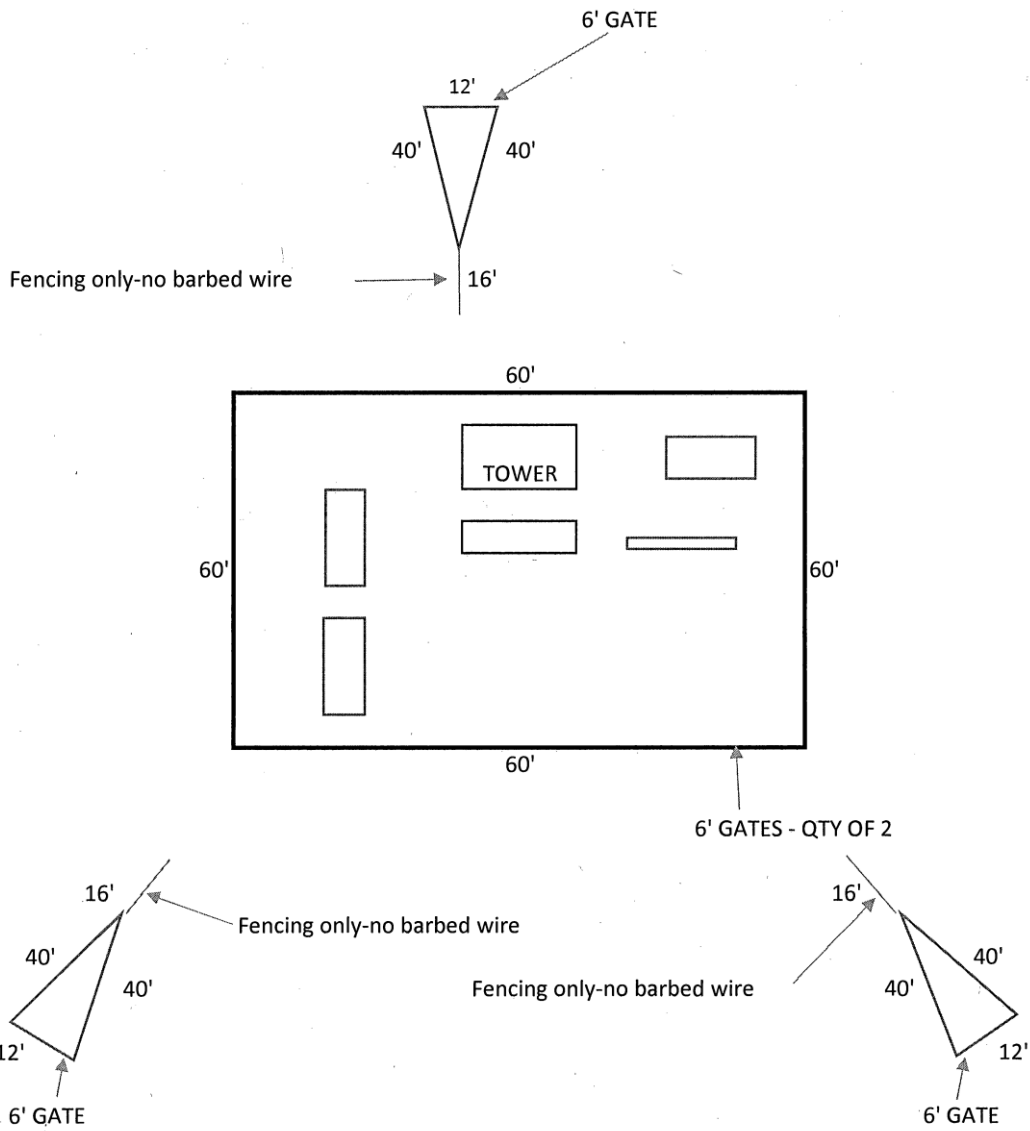

OAKWOOD TOWER

NOT TO SCALE

Illustration purposes only

- 168 FEET 8' FENCING AROUND TOWER STRUCTURES
- 102 FEET 8' FENCING AT EACH GUY ANCHOR - TOTAL 306 FEET
- QTY OF 5 GATES, 6' W X 8' H (2 AT TOWER, 1 AT EACH GUY ANCHOR)
- 3-STRAND BARBED WIRE ON ALL FENCING AND GATES

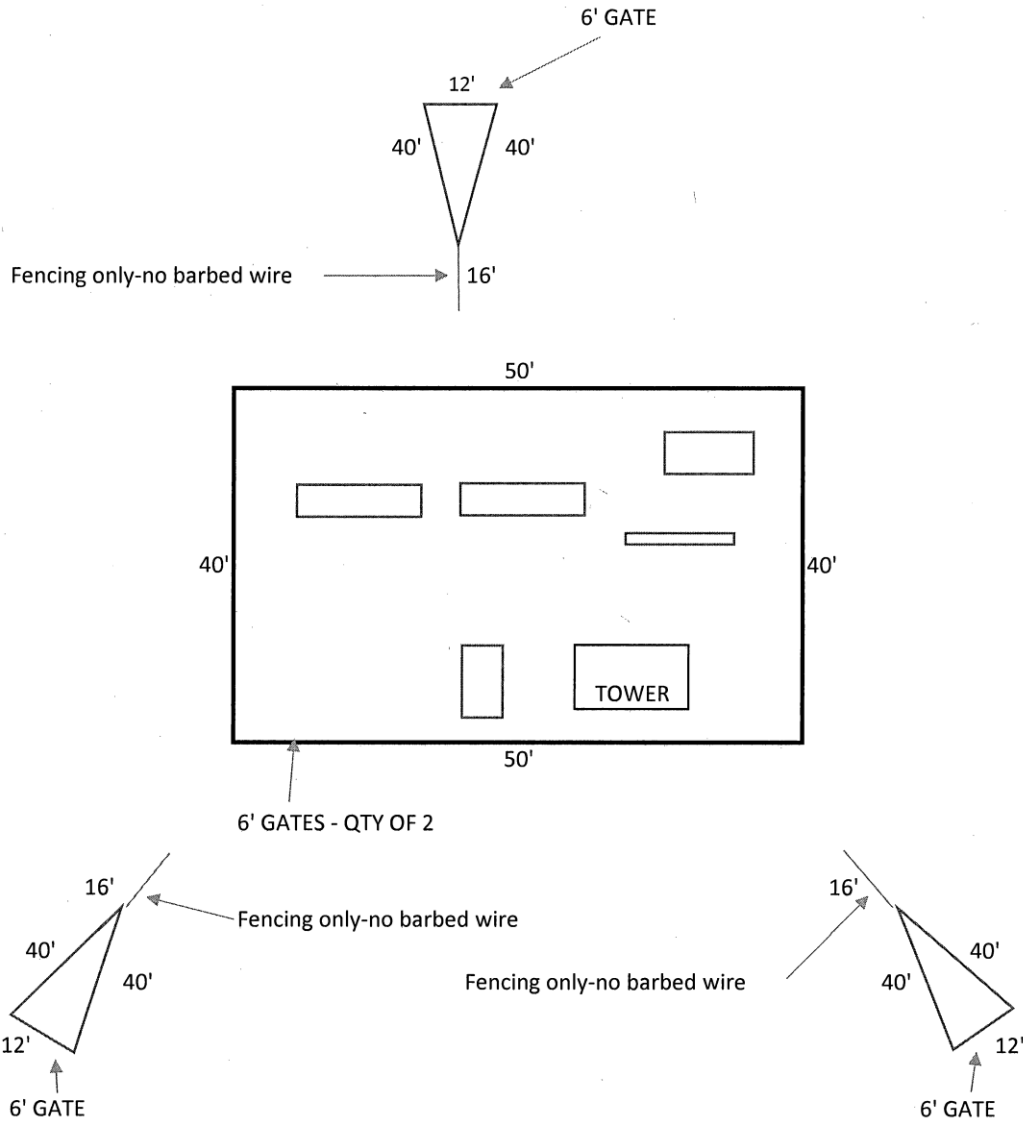

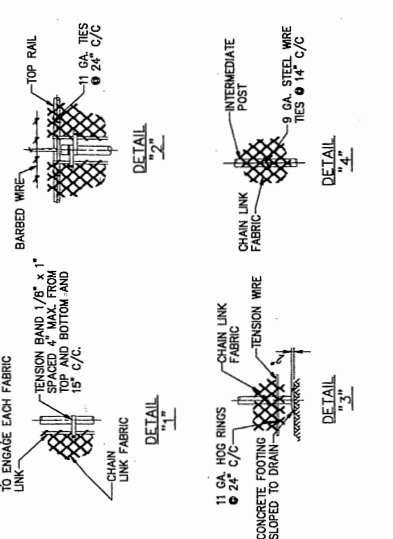
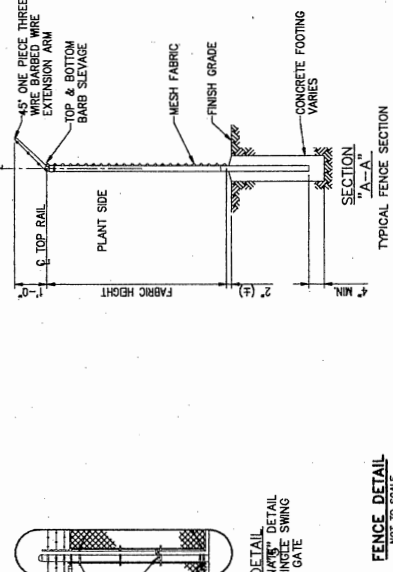
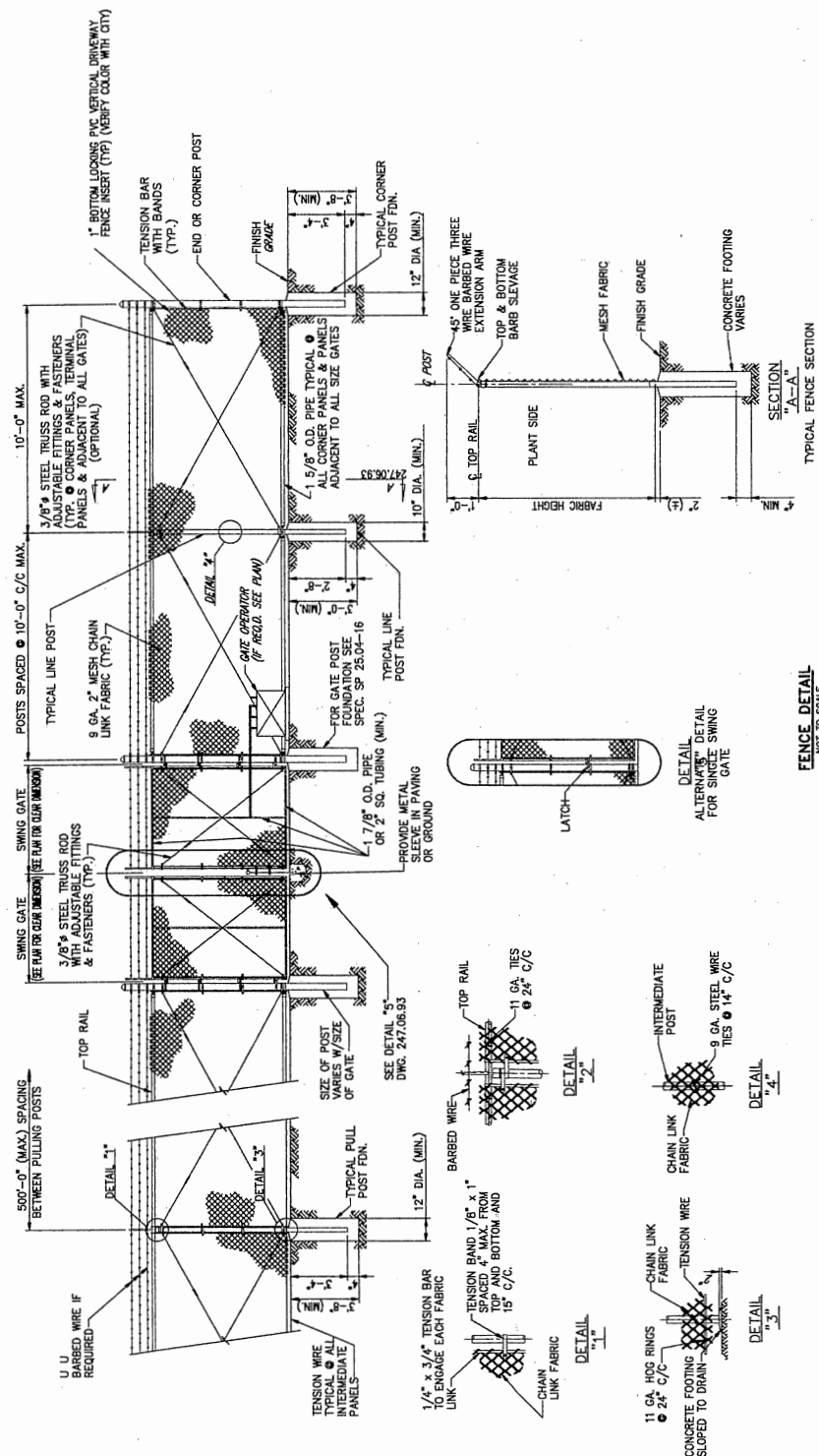
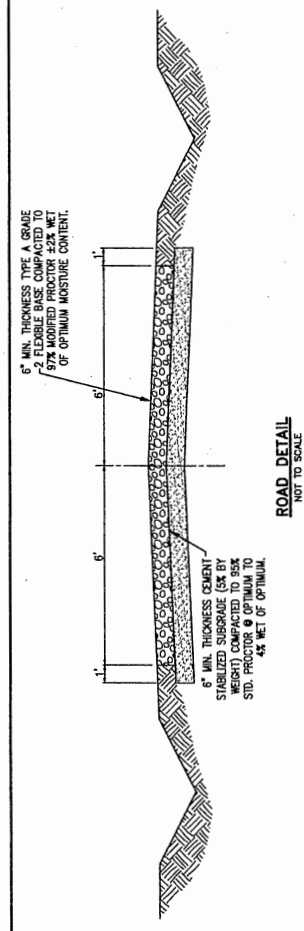

10/2017/2023-272B-30 28000-202 Engineer: Matthew 23 10/2017/2023-272B-30 28000-202 Engineer: Matthew 23 10/2017/2023-272B-30 28000-202 Engineer: Matthew 23

SURVEY NOTES:

1. Bearings shown hereon are based on The Texas Coordinate System of 1983, Central Zone.
2. This survey does not provide any determination concerning wetlands, fault lines, toxic waste or any other natural or artificial issues. Such matters should be directed by the client or prospective purchaser to an expert consultant.
3. According to Community Panel No. 4829004500 of the Federal Emergency Management Agency's Flood Insurance Rate Maps for Leon County, having an effective date of November 20, 2013, the subject tract is situated within Unshaded Zone "X", defined as areas determined to be outside the 500-year flood plain. This flood statement does not imply that the property or structures thereon will be free from flooding or flood damage. The property owner is advised that the area is not protected by man-made or natural courses. This flood statement shall not create liability on the part of the surveyor.
4. The surveyor has not been provided with construction plans showing the location of underground utilities. Underground utilities may exist which are not shown hereon.
5. Elevation shown hereon reference NAVD 88 Vertical Datum as determined by GPS observations. These observations were submitted to GPUS (Online Positioning User Services) for post processing from the sticic observations obtained in the field.
6. Visible improvements/utilities were located with this survey, no subsurface probing, excavation or exploration was performed for this survey. Underground utilities may exist which are not shown hereon.
7. Temporary Benchmark "A" being a railroad spike set in a 10" oak tree located approximately 81 feet west of the center of the road, bearing S 89° 58' 10" W, distance 158.01 feet, as shown hereon. ELEVATION = 558.01 feet NAVD 88, 2003 Adjustment.
8. LEON STAR 861 UTILITY LOCATION SERVICES was performed for this survey on March 6, 2017, to locate and mark all utilities. Ticket number 570576237 (www.leasestar81.com).

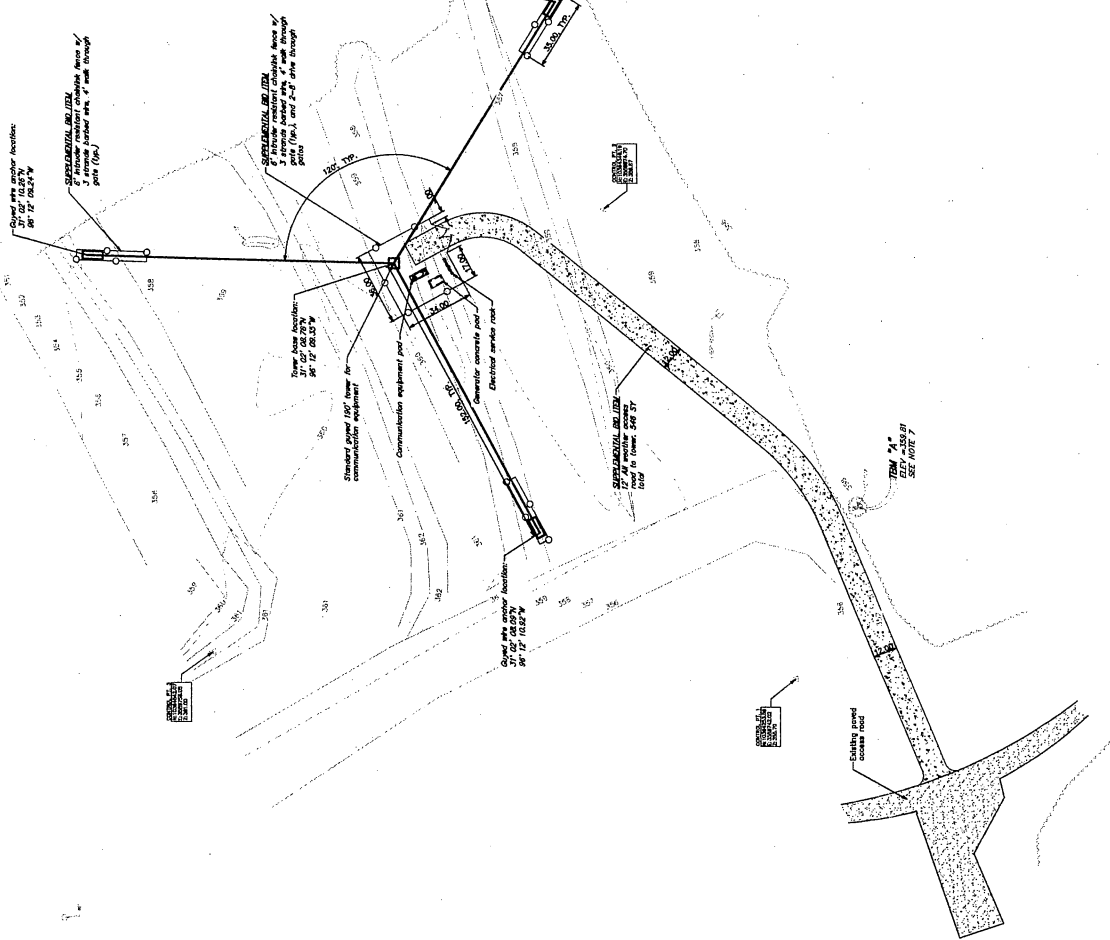

PROJECT NOTES:

1. All work to be done shall be in accordance with the specifications for this project. The communication tower shall be a standard tower with a height of 120 feet. If the tower is to be constructed on a pad, the pad shall be 10' x 10' and shall be constructed with 3 second gust wind speed of 90 mph. The tower shall be constructed with a minimum 555 or equivalent wind speed. Rein 555 or equivalent.
2. The tower contractor shall be required to supply tower & foundation drawings. The tower contractor shall be responsible for the construction of the tower in this state of Texas as part of the tower construction process.
3. Contract to include all site work and site restoration.

NO.	DATE	REVISIONS	BY	APP.

BRANCO VALLEY
COUNCIL OF GOVERNMENTS
BRAZOS COUNTY, TEXAS

**PROJECT SITE 1-6
NORMANGEE CITY PARK,
LEON CO., SITE PLAN**

JONES CARTER

DATE: AS NOTED
SCALE: AS NOTED
JOB NO.: 10221-5501-100
SUBMITTED: _____

DRAWN BY: ASH
DWG. NO.: 10221-5501-100
DATE: 10/19/2017

THIS DOCUMENT IS RELEASED
BY THE AUTHORITY OF
JONES CARTER
75% REVIEW
10/19/2017
IT IS NOT TO BE USED FOR
CONSTRUCTION WITHOUT AN
APPROPRIATE APPROVAL.

SHEET NO. 14
OF 30

NO. DATE	REVISIONS	APP.
BRAZOS VALLEY COUNCIL OF GOVERNMENTS BRAZOS COUNTY, TEXAS		
COMMUNICATION SYSTEM IMPROVEMENTS		
GENERAL CIVIL DETAILS 3		
SCALE	AS NOTED	DGN. BY: ASHAEZ
DATE	AS NOTED	DWG. BY:
JOB NO.	10261-001-00	DWG. NO.
SUBMITTED		SER. BY:

INTERIM REVIEW	
By: _____	Date: _____
Checked by: _____	
Date: _____	

SHEET NO. **50**
OF 50

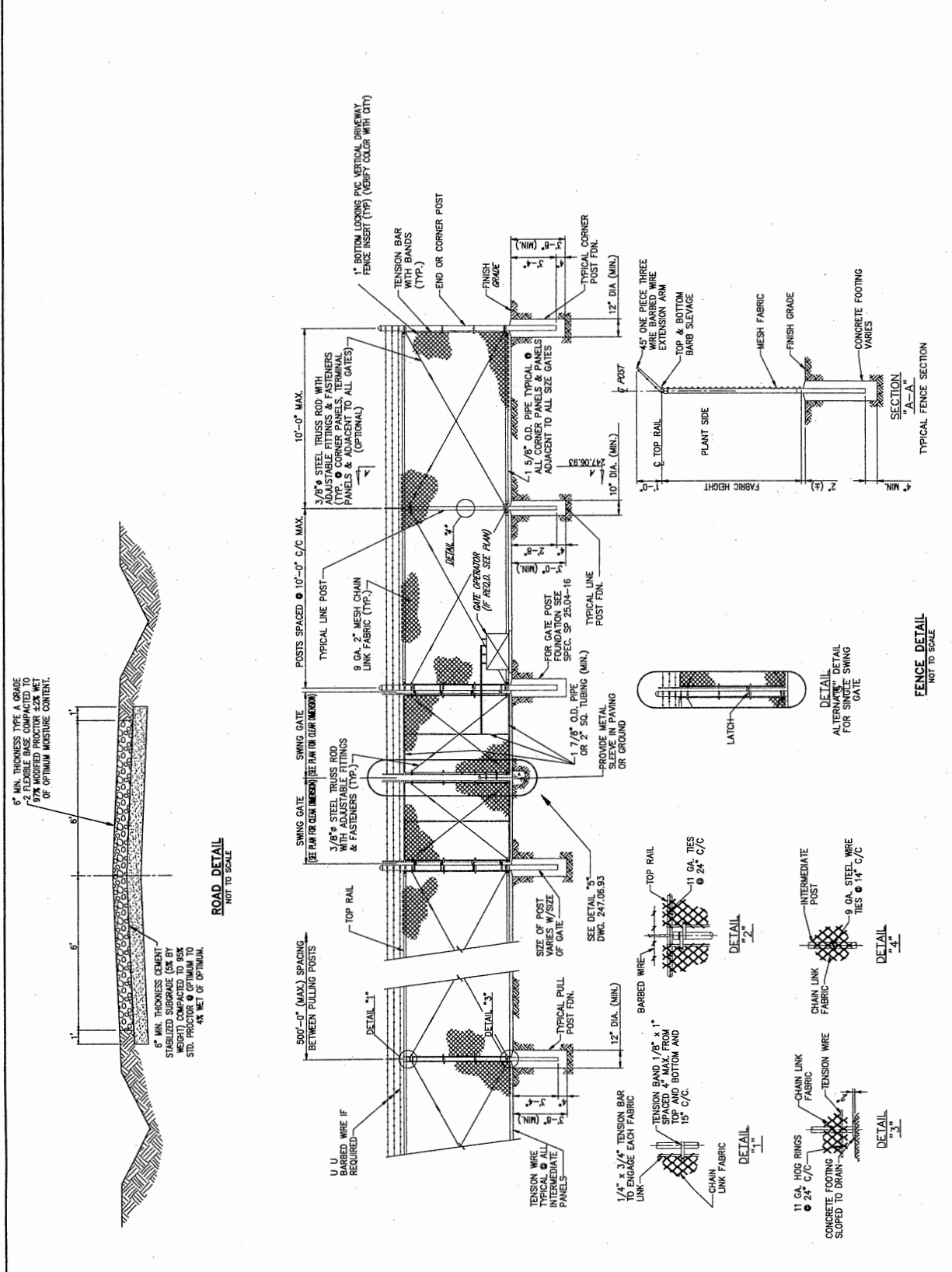

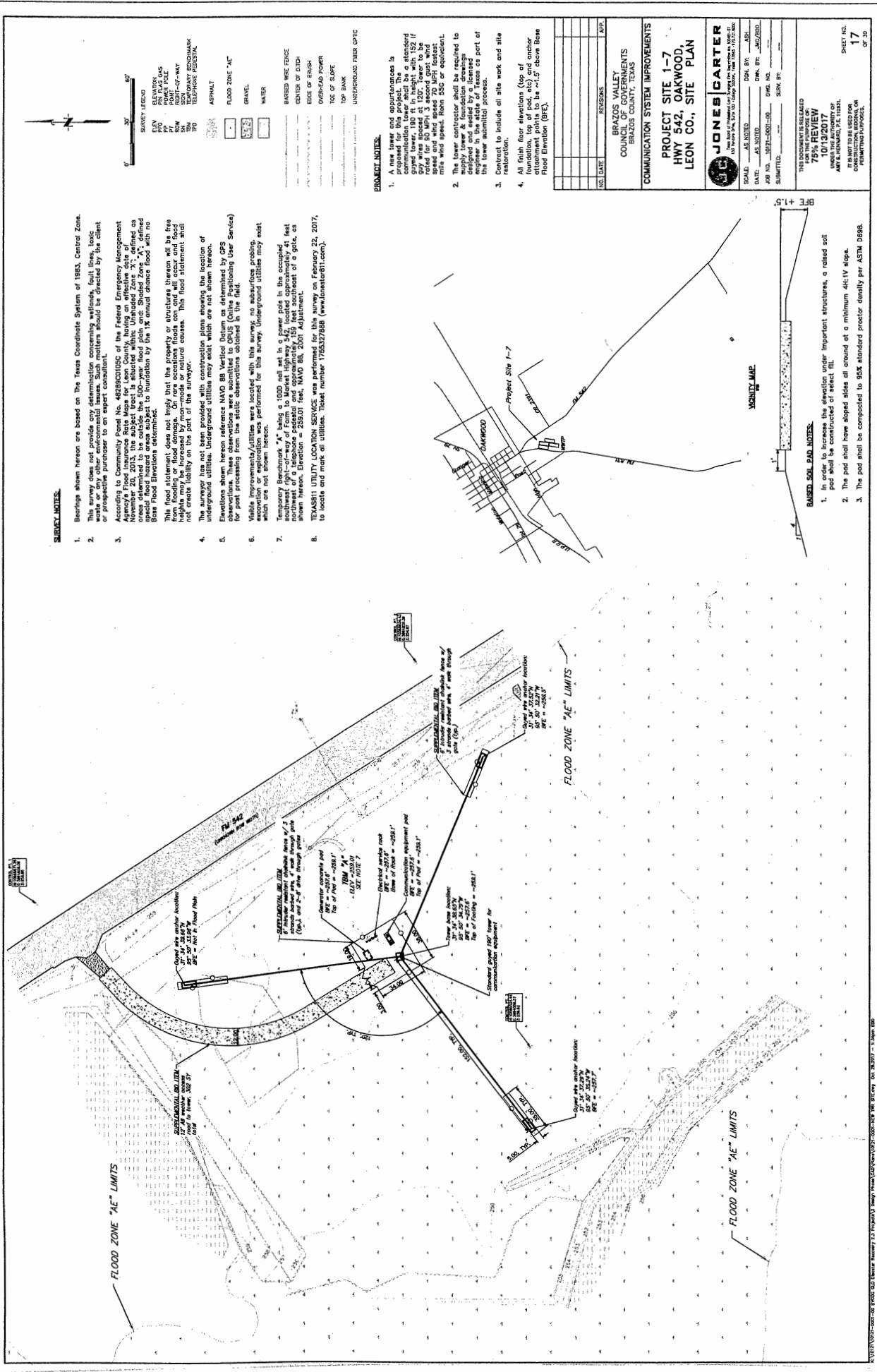

SURVEY NOTES:

1. Bearings shown hereon are based on the Texas Coordinate System of 1983, Central Zone.
2. This survey does not provide any determination concerning wetlands, flood lines, toxic waste or any other environmental issues. Such matters should be directed by the client to the appropriate agencies.
3. According to the County Flood Insurance Rate Map for Leon County, Texas, effective November 20, 2013, the subject tract is situated within Unshaded Zone "X", defined as areas of special flood hazard areas subject to inundation by the 1% annual chance flood with no Base Flood Elevations determined.
4. This flood statement does not imply that the property or structures thereon will be free from flooding. It only states that the property or structures thereon are located in an area where heights may be increased by man-made or natural causes. This flood statement shall not create liability on the part of the surveyor.
5. The surveyor has not been provided with construction plans showing the location of underground utilities. Underground utilities may exist within one or not shown hereon.
6. Elevation shown herein reference NAVD 88 Vertical Datum as determined by GPS measurements. The surveyor is not responsible for the accuracy of the existing User Service (US) data processing from the static observations obtained in the field.
7. Visible improvements/utilities were located with this survey; no subsurface probing, excavation or exploration was performed for this survey. Underground utilities may exist which are not shown hereon.
8. Temporary benchmark "T" being a 1000 mill set in a power pole in the occupied portion of the subject tract, approximately 155 feet southwest of a spot, as shown hereon. Elevation = 255.01 feet, NAVD 88, 2001 Adjustment.
9. TEXAS81 UTILITY LOCATION SERVICE was performed for this survey on February 22, 2017, to locate and mark all utilities. Ticket number 175537/888 (www.tonestor81.com).

PROJECT NOTES:

1. A new tower and appurtenances is to be constructed. The tower shall be a standard galvanized steel tower with a height of 152 feet. The tower shall be constructed with a 30 MPH, 3 second gust wind speed. The tower shall be constructed with a 1500 lb. wind speed. The tower shall be constructed with a 1500 lb. wind speed.
2. The tower contractor shall be required to supply tower & foundation drawings designed and sealed by a licensed professional engineer as part of the tower submitted process.
3. Contract to include all site work and site restoration.
4. All finish floor elevations (top of foundation, top of pad, etc) and anchor attachment points to be +1.5' above Base Flood Elevation (BFE).

BASED SOIL PAD NOTES:

1. In order to increase the elevation under important structures, a raised soil pad shall be constructed of select fill.
2. The pad shall have sloped sides all around at a minimum 4:1 V slope.
3. The pad shall be compacted to 95% standard proctor density per ASTM D888.

THIS DOCUMENT IS RELEASED
 75% REVIEW
 10/19/2017
 UNDER THE AUTHORITY OF
 JAMES W. JONES, P.E.
 IT IS NOT TO BE USED FOR
 CONSTRUCTION, RECORDING OR
 REPRODUCTION PURPOSES.

SCALE: AS NOTED
 DATE: AS NOTED
 JOB NO.: 175537-001-00
 SUBMITTED:

DRAWN BY: ASH
 CHECKED BY: JWC/2017
 SURV BY:

SUG. DATE: REVISIONS: DATE:

BRADCO VALLEY
 COMMUNICATIONS
 BRADCO COUNTY, TEXAS

PROJECT SITE 1-7
HWY 542, OAKWOOD,
LEON CO., SITE PLAN

JONES CARTER
 A Division of Jones & Jones, Inc.
 10000 Jones Road, Suite 1000, Houston, Texas 77036

SHEET NO. 17
 OF 30

BID FORM 2023-272B
Leon County
Fencing Construction and Installation

Bidder Name: _____

Bidder Address: _____

Bidder Phone: _____

Normangee Tower Location Bid Amount \$ _____

Oakwood Tower Location Bid Amount \$ _____

SIGNATURE PAGE

As permitted under Article 4413 (32c) V.A.C.S., other governmental entities may wish to participate under the same terms and conditions contained in this contract (i.e., piggyback). In the event any other entity participates, all purchase orders will be issued directly from and shipped directly to the entity requiring supplies/services. Leon County shall not be held responsible for any orders placed, deliveries made or payment for supplies/services ordered by another entity. Each entity reserves the right to determine their participation in this contract.

Would bidder be willing to allow other governmental entities to piggyback off this contract, if awarded, under the same terms and conditions? **Yes π No π**

This bid shall remain in effect for ninety (90) days from bid opening and shall be exclusive of federal excise and state and local sales tax (exempt).

The undersigned agrees, if this bid is accepted, to furnish any and all items upon which prices are offered, at the price and upon the terms and conditions contained in the Invitation for Bid, Conditions of Bidding, Terms of Contract, and Specifications and all other items made a part of the accepted contract.

The undersigned affirms that they are duly authorized to execute the contract, that this company, corporation, firm, partnership, or individual has not prepared this bid in collusion with any other bidder, and that the contents of this bid as to prices, terms, or conditions of said bid have not been communicated by the undersigned nor by any employee or agent to any other bidder or to any other person(s) engaged in this type of business prior to the official opening of this bid. And further, that neither the bidder nor their employees nor agents have been for the past six (6) months directly nor indirectly concerned in any pool or agreement or combination to control the price of goods or services on, nor to influence any person to bid or not to bid thereon.

Bidder (Entity Name)

Signature

Street & Mailing Address

Print Name

City, State & Zip

Date Signed

Telephone Number

Fax Number

E-mail Address

OFFER AND ACCEPTANCE FORM

OFFER TO CONTRACT

To Leon County:

We hereby offer and agree to furnish the materials or service in compliance with all terms, conditions, specifications, and amendments in the Invitation for Bid and any written exceptions in the offer. We understand that the items in this Invitation for Bid, including, but not limited to, all required certificates are fully incorporated herein as a material and necessary part of the contract.

The undersigned hereby states, under penalty of perjury, that all information provided is true, accurate, and complete, and states that he/she has the authority to submit this bid, which will result in a binding contract if accepted by Leon County.

We acknowledge receipt of the following amendment(s): _____, _____, _____, _____.

I certify, under penalty of perjury, that I have the legal authorization to bind the firm hereunder:

_____	For clarification of this offer, contact:		
Company Name	_____		
_____	Name		
Address	_____		
_____	Phone		
City	State	Zip	Fax
_____	_____		
Signature of Person Authorized to Sign	E-mail		
_____	_____		
Printed Name	_____		
_____	_____		
Title	_____		

ACCEPTANCE OF OFFER

The Offer is hereby accepted for the following items: **Fencing Construction and Installation**

The Contractor is now bound to sell the materials or services listed by the attached contract and based upon the Invitation for Bid, including all terms, conditions, specifications, amendments, etc., and the Contractor's Offer as accepted by Leon County.

This contract shall henceforth be referred to as Contract No. **2023-272B**. The Contractor has not been authorized to commence any billable work or to provide any material or service under this contract until Contractor receives a purchase order and/or a notice to proceed from the Leon County Auditor's Office.

Countersigned:

Byron Ryder, Leon County Judge

Date